

U_FLOE with two armrest



Type of fabric	<i>bond, keimo, sawana</i>	<i>charles, charles SD*, pastel, roccia, valencia</i>	<i>blazer, crisp, fame, silvertex, synergy, synergy SD*, entrusted fabrics</i>	<i>remix 2, remix 2 SD*, leather, client's own leather</i>	Studio Design
	1	2	3	4	5
UF 120	562	605	667	889	987
UF 121	685	733	801	1 050	1 167
UF 2200	661	713	787	1 051	1 168
UF 2210	784	841	922	1 213	1 348
UF 2211	906	969	1 056	1 375	1 527
UF 32000	796	854	936	1 228	1 365
UF 32100	919	982	1 071	1 390	1 544
UF 32110	1 042	1 110	1 205	1 551	1 724
UF 32111	1 165	1 238	1 340	1 713	1 903

* Information on the possible use of fabrics from the Studio Design offer - table page 9

Attention! In order to properly arrange the backrests in sofas, please modify the product code according to the sample



Base	CODE		EUR
Powder painted rod base (coloring according to Bejot's pattern book)		●	
Chromed rod base		○	+42
Armrests			
Top of the armrest is upholstered in the same colour as upholstery		●	
Top of the armrest (2 pcs) upholstered in different colour within the same upholstery group		○	+34
Top of the armrest (2 pcs) upholstered with keimo or valencia, for armrests upholstered with fabric		○	+67
Top of the armrest (2 pcs) upholstered with silvertex or leather, for armrests upholstered with fabric		○	+99
Slides			
Glides for ceramic floors, concrete and carpets	PK	●	
Felt glides for wooden floors and floor panels	PF	○	+7

U-Floe components are supplied in a partially disassembled form.

Recommended retail prices in EUR exclusive of VAT

● STANDARD ○ OPTION

U_FLOE with one armrest



modularity

Studio Design

UF 110 L



UF 111 L



UF 2100 R

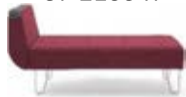

UF 2110 R



UF 2111 L



UF 31000 L

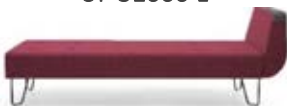

UF 31100 R



Type of fabric	<i>bond, keimo, sawana</i>	<i>charles, charles SD*, pastel, roccia, valencia</i>	<i>blazer, crisp, fame, silvertex, synergy, synergy SD*, entrusted fabrics</i>	<i>remix 2, remix 2 SD*, leather, client's own leather</i>	Studio Design
	1	2	3	4	5
UF 110 L/R	432	463	508	672	746
UF 111 L/R	555	591	642	833	926
UF 2100 L/R	530	571	629	835	927
UF 2110 L/R	653	699	763	996	1 107
UF 2111 L/R	776	826	897	1 158	1 286
UF 31000 L/R	666	712	778	1 011	1 124
UF 31100 L/R	789	840	912	1 173	1 303
UF 31110 L/R	911	968	1 046	1 335	1 483
UF 31111 L/R	1 034	1 095	1 181	1 496	1 662

* Information on the possible use of fabrics from the Studio Design offer - table page 9

** Modular elements - it is not possible to use it as a free-standing one

Attention! In order to properly arrange the backrests in sofas, please modify the product code according to the sample

UF 31110 R



UF 31111 L



L - armrest on the left side of the sitting person

R - armrest on the right side of the sitting person

Base	CODE		EUR
Powder painted rod base (coloring according to Bejot's pattern book)		●	
Chromed rod base		○	+42
ArmrestsL or R			
Top of the armrest is upholstered in the same colour as upholstery		●	
Top of the armrest (1 pcs) upholstered in different colour within the same upholstery group		○	+17
Top of the armrest (1 pcs) upholstered with keimo or valencia, for armrests upholstered with fabric		○	+34
Top of the armrest (1 pcs) upholstered with silvertex or leather, for armrests upholstered with fabric		○	+50
Additional equipment			
The seat connector to connect two seats (set)	L-PQ	○	+23
Slides			
Glides for ceramic floors, concrete and carpets	PK	●	
Felt glides for wooden floors and floor panels	PF	○	+7

U-Floe components are supplied in a partially disassembled form.

U_FLOE without armrest



UF 100



UF 101



UF 2000



UF 2010



UF 2011



UF 30000



UF 30100



UF 30110



UF 30111



Type of fabric	<i>bond, keimo, sawana</i>	<i>charles, charles SD*, pastel, roccia, valencia</i>	<i>blazer, crisp, fame, silvertex, synergy, synergy SD*, entrusted fabrics</i>	<i>remix 2, remix 2 SD*, leather, client's own leather</i>	Studio Design
	1	2	3	4	5
UF 100	301	321	349	455	505
UF 101	424	449	484	616	685
UF 2000	400	429	470	618	686
UF 2010	522	556	604	779	866
UF 2011	645	684	739	941	1 045
UF 30000	535	570	619	795	883
UF 30100	658	698	753	956	1 062
UF 30110	781	825	888	1 118	1 242
UF 30111	904	953	1 022	1 279	1 421

* Information on the possible use of fabrics from the Studio Design offer - table page 9

Attention! In order to properly arrange the backrests in sofas, please modify the product code according to the sample

Base	CODE		EUR
Powder painted rod base (coloring according to Bejot's pattern book)		●	
Chromed rod base		○	+42
Additional equipment			
The seat connector to connect two seats (set)	L-PQ	○	+23
Slides			
Glides for ceramic floors, concrete and carpets	PK	●	
Felt glides for wooden floors and floor panels	PF	○	+7

U-Floe components are supplied in a partially disassembled form.

Recommended retail prices in EUR exclusive of VAT

● STANDARD ○ OPTION

U_FLOE wood with two armrest



UF W 120



UF W 121



UF W 2200



UF W 2210



UF W 2211



UF W 32000



UF W 32100



Type of fabric	<i>bond, keimo, sawana</i>	<i>charles, charles SD*, pastel, roccia, valencia</i>	<i>blazer, crisp, fame, silvertex, synergy, synergy SD*, entrusted fabrics</i>	<i>remix 2, remix 2 SD*, leather, client's own leather</i>	Studio Design
	1	2	3	4	5
UF W 120	644	687	748	970	1 069
UF W 121	766	815	882	1 131	1 248
UF W 2200	742	794	869	1 133	1 250
UF W 2210	865	922	1 003	1 294	1 429
UF W 2211	988	1 050	1 137	1 456	1 609
UF W 32000	878	935	1 018	1 310	1 446
UF W 32100	1 000	1 063	1 152	1 471	1 625
UF W 32110	1 123	1 191	1 286	1 633	1 805
UF W 32111	1 246	1 319	1 421	1 794	1 985

* Information on the possible use of fabrics from the Studio Design offer - table page 9

Attention! In order to properly arrange the backrests in sofas, please modify the product code according to the sample

UF W 32110



UF W 32111



Base	CODE	EUR
Legs made of ash wood (coloring according to Bejot's pattern book)		●
Armrests		
Top of the armrest is upholstered in the same colour as upholstery		●
Top of the armrest (2 pcs) upholstered in different colour within the same upholstery group		○ +34
Top of the armrest (2 pcs) upholstered with keimo or valencia, for armrests upholstered with fabric		○ +67
Top of the armrest (2 pcs) upholstered with silvertex or leather, for armrests upholstered with fabric		○ +99

U-Floe components are supplied in a partially disassembled form.

U_FLOE wood with one armrest



UF W 110L**



UF W 111R**



UF W 2100 R



UF W 2110 R



UF W 2111 R



UF W 31000 L



UF W 31100 R



Type of fabric	<i>bond, keimo, sawana</i>	<i>charles, charles SD*, pastel, roccia, valencia</i>	<i>blazer, crisp, fame, silvertex, synergy, synergy SD*, entrusted fabrics</i>	<i>remix 2, remix 2 SD*, leather, client's own leather</i>	Studio Design
	1	2	3	4	5
UF W 110 L/R **	513	545	589	753	828
UF W 111 L/R **	636	672	724	915	1 007
UF W 2100 L/R	611	652	710	916	1 009
UF W 2110 L/R	734	780	844	1 077	1 188
UF W 2111 L/R	857	908	979	1 239	1 368
UF W 31000 L/R	747	793	859	1 093	1 205
UF W 31100 L/R	870	921	993	1 254	1 385
UF W 31110 L/R	993	1 049	1 128	1 416	1 564
UF W 31111 L/R	1 115	1 177	1 262	1 577	1 744

* Information on the possible use of fabrics from the Studio Design offer - table page 9

** Modular elements - it is not possible to use it as a free-standing one

Attention! In order to properly arrange the backrests in sofas, please modify the product code according to the sample

UF W 31110 R



UF W 31111 R



L - armrest on the left side of the sitting person

R - armrest on the right side of the sitting person

Base	CODE	EUR
Legs made of ash wood (coloring according to Bejot's pattern book)		•
ArmrestsL or R		
Top of the armrest is upholstered in the same colour as upholstery		•
Top of the armrest (1 pcs) upholstered in different colour within the same upholstery group		○ +17
Top of the armrest (1 pcs) upholstered with keimo or valencia, for armrests upholstered with fabric		○ +34
Top of the armrest (1 pcs) upholstered with silvertex or leather, for armrests upholstered with fabric		○ +50
Additional equipment		
The seat connector to connect two seats (set)	L-PQ	○ +23

U-Floe components are supplied in a partially disassembled form.

U_FLOE wood without armrest



UF W 100



UF W 101



UF W 2000



UF W 2010



UF W 2011



UF W 30000



UF W 30100

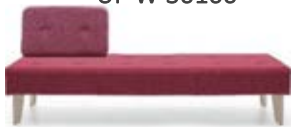

Type of fabric	<i>bond, keimo, sawana</i>	<i>charles, charles SD*, pastel, roccia, valencia</i>	<i>blazer, crisp, fame, silvertex, synergy, synergy SD*, entrusted fabrics</i>	<i>remix 2, remix 2 SD*, leather, client's own leather</i>	Studio Design
	1	2	3	4	5
UF W 100	382	402	430	536	587
UF W 101	505	530	565	698	766
UF W 2000	481	510	551	699	768
UF W 2010	604	638	685	860	947
UF W 2011	726	765	820	1 022	1 127
UF W 30000	616	651	700	876	964
UF W 30100	739	779	835	1 037	1 144
UF W 30110	862	907	969	1 199	1 323
UF W 30111	985	1 035	1 103	1 360	1 503

* Information on the possible use of fabrics from the Studio Design offer - table page 9

Attention! In order to properly arrange the backrests in sofas, please modify the product code according to the sample

UF W 30110



UF W 30111



Base	CODE		EUR
Legs made of ash wood (coloring according to Bejot's pattern book)		●	
Additional equipment			
The seat connector to connect two seats (set)	L-PQ	○	+23

U-Floe components are supplied in a partially disassembled form.

U_FLOE Parts connecting sets



Armrests

UF P2



UF P2 + E2VCC



UF P2B



UF P2B + E2VCC



Type of fabric	<i>bond, keimo, sawana</i>	<i>charles, charles SD*, pastel, roccia, valencia</i>	<i>blazer, crisp, fame, silvertex, synergy, synergy SD*, entrusted fabrics</i>	<i>remix 2, remix 2 SD*, leather, client's own leather</i>	Studio Design
	1	2	3	4	5
UF P2 Middle armrest	168	183	205	280	311
UF P2B Middle armrest with top	235	250	271	347	378

* Information on the possible use of fabrics from the Studio Design offer - table page 9

Armrests do not appear as independent elements- - they can be used to connect 2 sofas u floe into a set.

Armrest	CODE		EUR
Top of the armrest is upholstered in the same colour as upholstery		●	
Top of the armrest upholstered in different colour within the same upholstery group		○	+17
Top of the armrest upholstered in keimo or valencia for armrests upholstered with fabric		○	+34
Top of the armrest upholstered with silvertex or leather, for armrests upholstered with fabric		○	+50

Colors of HPL tops - UF P2B

White with a black core		○	
Black with a black core		○	

Additional equipment

Mediaport (white-W or black-B): 1 voltage socket 230V (type E-Poland/ France or type F-Germany, or type G-Great Britain) + 2 x USB chargers	[type]2VCC	○	+251
Mediaport(white-W or black-B): 2 voltage sockets 230V (type E-Poland/ France or type F-Germany, or type G-Great Britain)	[type]2VV	○	+140

Connectors made of HPL table tops

UF TB45



UF TB90

UF TB180

UF TB180 C

Type of top	HPL (thickness of the table top 10 mm)
UF TB45 Set connector 45°	168
UF TB90 set connector 90°	193
UF TB180 Set connector 180°	174
UF TB180 C Set connector 180°	186

Table tops do not appear as independent elements- - they can be used to connect 2 sofas u floe into a set.

Colours of the HPL table top	CODE		EUR
White with a black core		○	
Black with a black core		○	

U_FLOE box



Type of fabric	<i>bond, keimo, sawana</i>	<i>charles, charles SD*, pastel, roccia, valencia</i>	<i>blazer, crisp, fame, silvertex, synergy, synergy SD*, entrusted fabrics</i>	<i>remix 2, remix 2 SD*, leather, client's own leather</i>	Studio Design
	1	2	3	4	5
UF BOX	433	453	482	591	656
UF TB	382	402	431	540	600
UF PP	37	44	54	85	94

* Information on the possible use of fabrics from the Studio Design offer - table page 9

* UF BOX - product is not waterproof. The manufacturer is not responsible for improper use of the enduser.

Base of UF BOX/ UF TB	CODE	EUR
Feet made from black material		•

Colours of the HPL table tops UF BOX/ UF TB	CODE	EUR
White with a black core		○
Black with a black core		○

Additional equipment UF BOX	CODE	EUR
Additional table top HPL	T	○ +82

U_FLOE step over



Type of top	<i>Melamine (table top thickness 18 mm)</i>	<i>HPL (thickness of the table top 10 mm)</i>
UF STOV L dimensions 600mm x 1244mm; h:1010mm	266	401
UF STOV H dimensions 600mm x 1244mm; h:1800mm	342	477
UF STOV F dimensions 648mm x 1198mm; h:1010mm		608

* Presented plants are not part of the set

Base	CODE	EUR
Rod base power painted in colours RAL (7022, 7024, 9005, 9010, ALU)		•

Colours of the Melamine table top	CODE	EUR
Coloring according to Bejot's pattern book		•

Colours of the HPL table top	CODE	EUR
White with a black core		○
Black with a black core		○

Slides	CODE	EUR
Glides for ceramic floors, concrete and carpets	PK	•
Felt glides for wooden floors and floor panels	PF	○ +7

U_FLOE new

UF SCD12

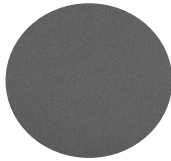

UF SC12

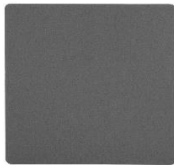

Type of fabric	<i>bond, sawana</i>	<i>charles, charles SD*, fighter, pastel, roccia</i>	<i>blazer, crisp, fame, synergy, synergy SD*</i>	<i>remix 2</i>	<i>Studio Design</i>
	1	2	3	4	5
UF SCD12 fi 1200 mm	210	250	306	496	552
UF SC12 1200x1200 mm	210	250	306	496	552

The element is an integral part of the u_floe module with the backrest. There is no possibility of independent purchase.



Instruction of indexing of the UFLOE collection



UF101

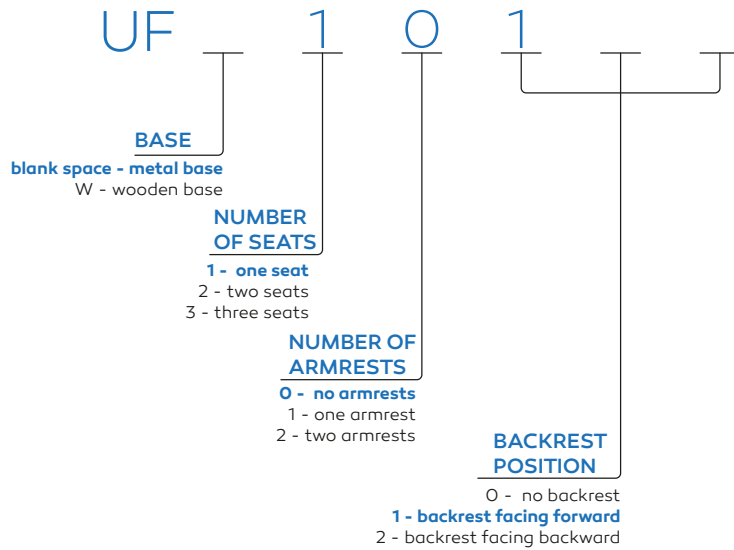

UF2010

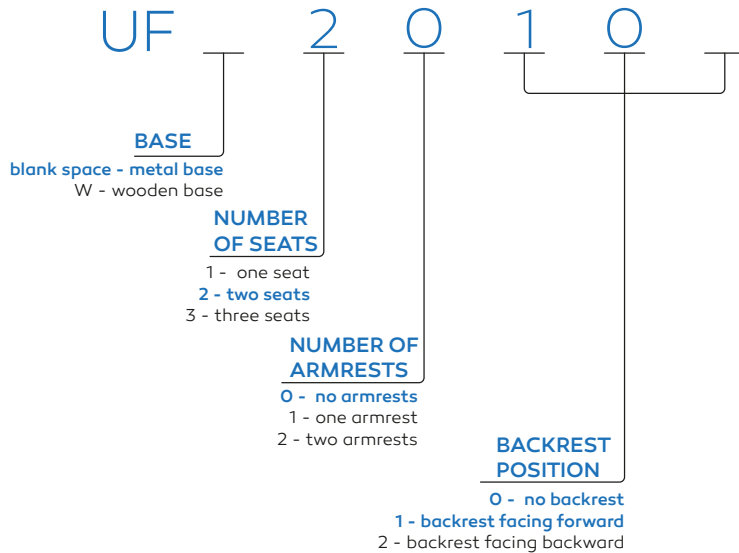

UFW31121R

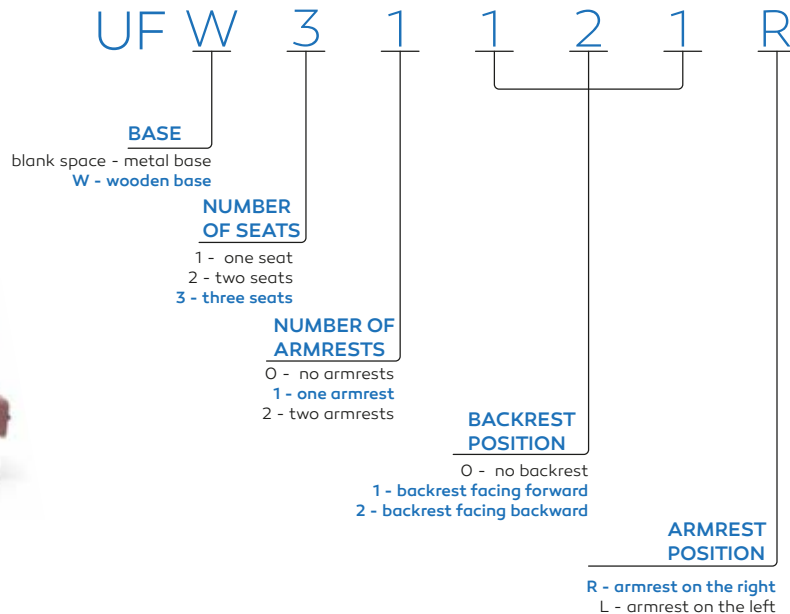

Examples of connecting U_FLOE sofas, walls and tables

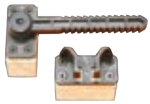

L-PQ

MS-SIM-8-40*

L-PA

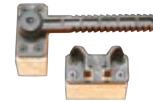
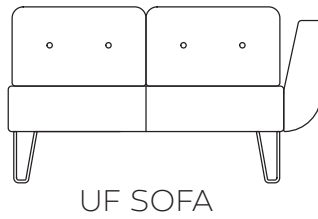
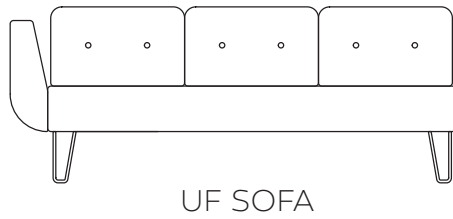

L-PQ

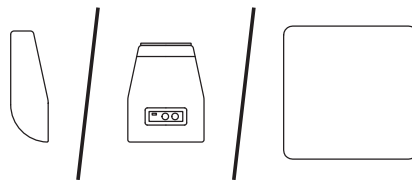
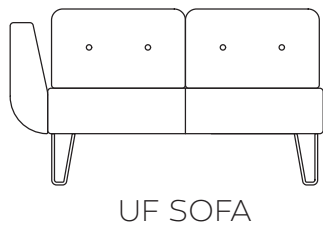

MS-SIM-8-40*

UFL/UFR/UFP2/UFP2M, UFPB2, UFP2M, UFP2BM
UFTB45/UFTB90/UFTB180/UFTB180C

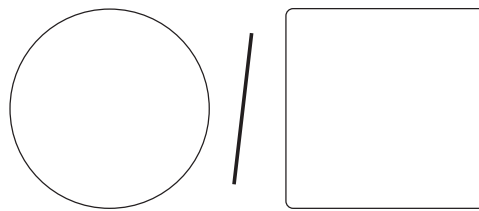
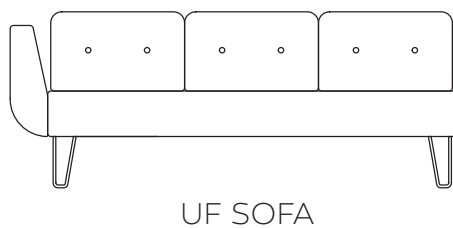

L-PA*

UF SC12/UF SCD12

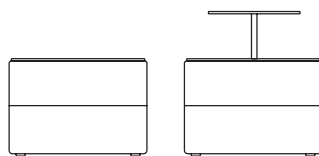
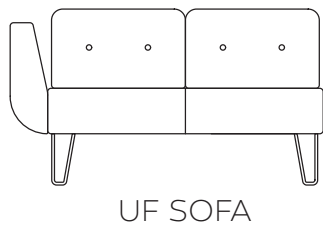

**No
connector**

UF TB/UF BOX/UF BOX+T

- 1x UF BOX
- 1x UF 101
- 1x UF TB180
- 1x UF 2011L
- 1x UF SCD12
- 12x MS-SIM-8-40*
- 3x L-PA*

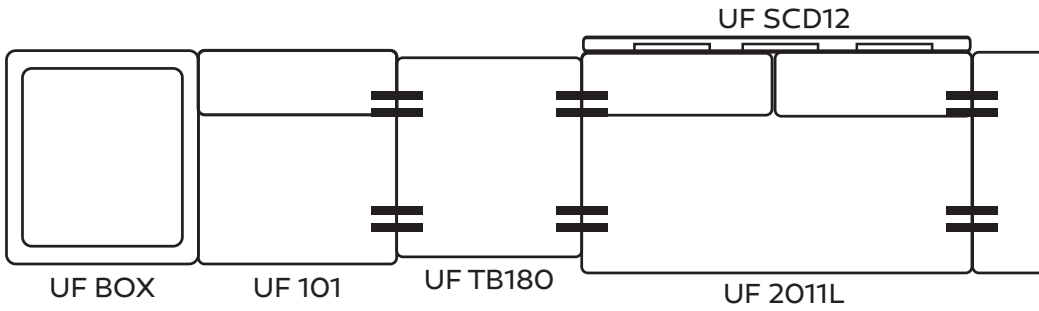
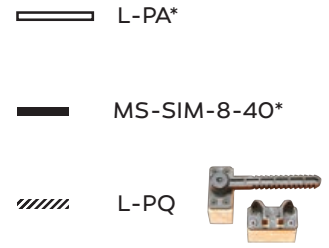

- 1x UF 111R
- 1x UF TB180
- 1x UF STEP OVER
- 1x UF 2011
- 1x UF 2011L
- 1x UF SC12
- 16x MS-SIM-8-40*
- 3x L-PA*
- 2x L-PQ

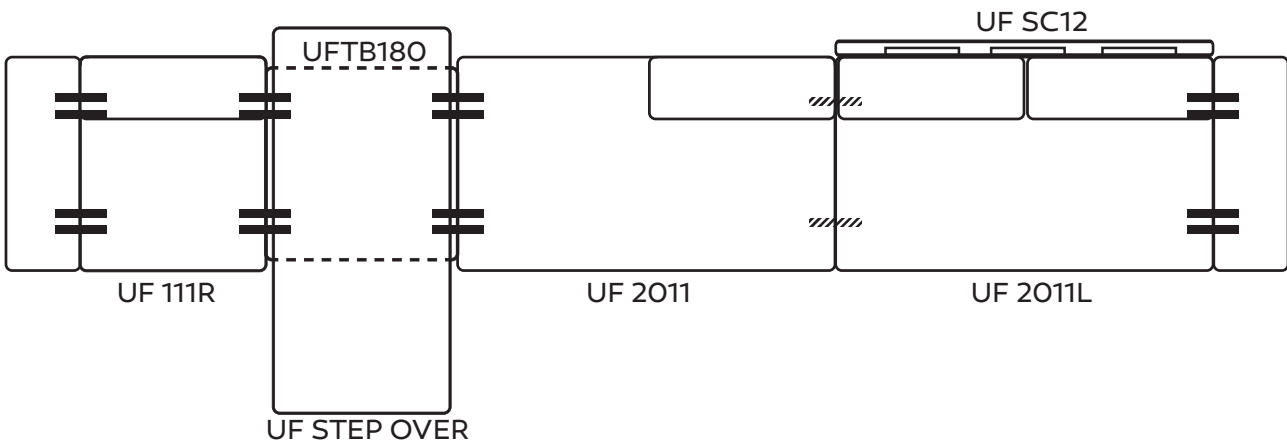

*L-PA connectors and MS-SIM-8-40 screws belong to standard equipment and there is no need to order them separately.