

Listini in vigore dal 1 Gennaio 2019
Price lists in effect from January 1st 2019
Listes de prix en vigueur à partir du 1er Janvier 2019
Tarifa de precios en vigor del 1 de Enero de 2019

Indice

Index | Index | Índice

04

Caratteristiche tecniche

Technical descriptions | Caracteristiques techniques | Caracteristicas tecnicas

12

Finiture

Finishes | Finitions | Acabados

18

Scrivanie H. 73,4

Desks H. 73,4 | Bureaux H. 73,4 | Mesas H. 73,4

24

Dattilo agganciati H. 73,4

Hanging return H. 73,4 | Retours accrochés H. 73,4 | Alas suspendidas H. 73,4

27

Tavoli riunione H. 73,4

Meeting tables H. 73,4 | Tables de réunion H. 73,4 | Mesas de juntas H. 73,4

35

Tavolini da caffè H. 40

Coffee tables H. 40 | Tables basses H. 40 | Mesitas H. 40

40

Modesty panel

Modesty panel | Voile de fond | Faldón

41

Piani scrivania

Desk tops | Plateaux bureaux | Sobres mesa

43

Piani dattilo

Return tops | Plateaux retour | Sobres ala

45

Piani tavoli riunione

Top for meeting tables | Plateaux tables de réunion | Sobres para mesas de juntas

48

Telai per piani sp. 1,8

Frames for 1,8 thick top | Châssis pour plateau ép. 1,8 | Estructuras para mesas esp. 1,8

52

Telai per piani sp. 0,8

Frames for 0,8 thick top | Châssis pour plateau ép. 0,8 | Estructuras para mesas esp. 0,8



56

Telai per piani sp. 0,6

Frames for 0,6 thick top | Châssis pour plateau ép. 0,6 | Estructuras para mesas esp. 0,6

60

Gambe

Legs | Piètements | Patas

62

Basamenti

Bases | Base de support | Base central

65

Accessori

Accessories | Accessoires | Accesorios

ERACLE

è una collezione direzionale di alto livello caratterizzata da un telaio in profilo di alluminio combinato con gambe sfaccettate rivestite in lamina di alluminio.

01

Scrivanie

Le gambe sono realizzate in multistrato fenolico e rivestite con una lamina in alluminio anodizzato o rivestite in cuoio. Le gambe sono prodotte con un particolare processo denominato "folding", che conferisce alla gamba una forma sfaccettata.

Le scrivanie sono disponibili nelle seguenti varianti:

- con quattro gambe angolari (tipologia A);
- con due gambe pannellate (tipologia B);
- con due gambe angolari e un basamento a diamante (tipologia C).

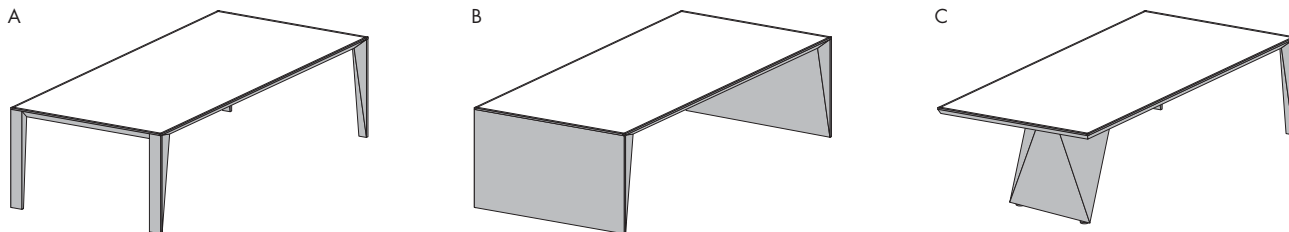

Il telaio che accoglie il piano scrivania è realizzato con un estruso in alluminio anodizzato a sezione triangolare di dimensioni 116x79,5 mm.

I piani lavoro sono disponibili in:

- nobilitato melaminico, spessore 18 mm con bordo in ABS 2 mm;
 - impiallacciato, spessore 18 mm con bordo legno 1 mm;
 - nobilitato melaminico, rivestito in cuoio 2 mm con cuciture in vista;
 - gres porcellanato, spessore 6 mm (supportato da un pannello nobilitato melaminico, spessore 12 mm);
 - vetro extrachiaro spessore 8 mm, goffrato all'acqua sulla parte inferiore ed eventuale trattamento anti-impronta sulla parte superiore.
- Le giunzioni angolari sono realizzate in lega di zama.

02

Dattilo

La collezione Eracle è arricchita da dattilo indipendenti o agganciati. Quest'ultima tipologia viene agganciata alla struttura della scrivania attraverso un'apposita staffa in metallo. I dattilo sono realizzati con le stesse specifiche delle scrivanie.

03

Modesty

Al telaio può essere fissato un modesty panel dello spessore di 18 mm, anch'esso disponibile in diverse finiture:

- nobilitato melaminico;
- impiallacciato in essenza di legno precomposto;
- nobilitato in melaminico, rivestito in cuoio 2 mm con cuciture in vista;
- goffrato.

04

Tavoli riunione

I tavoli riunione hanno forma quadrata o rettangolare ed è possibile scegliere tra le seguenti tipologie:

- con quattro gambe angolari (tipologia A);
- con due basamenti (tipologia B);
- con due gambe angolari e un basamento a diamante (tipologia C).

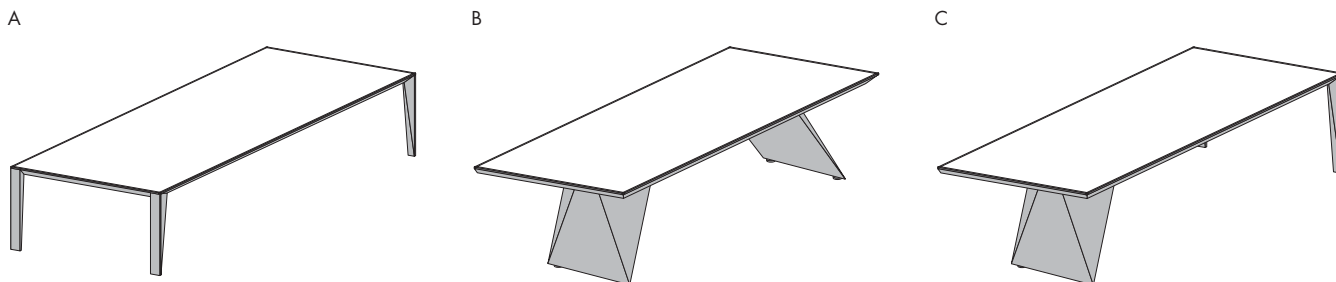

05

Tavolini da caffè

Eracle dispone di tavolini da caffè H.400 mm a gambe angolari con le stesse specifiche riportate per le scrivanie.

06

Elettrificazione

I piani di scrivanie e tavoli riunione possono essere dotati di passacavi in PVC di varie dimensioni e di top access modulari realizzati in alluminio. Questi elementi sono posizionabili su richiesta.

Per l'elettrificazione è possibile applicare alle scrivanie un portacavi in filo d'acciaio fissato al telaio.

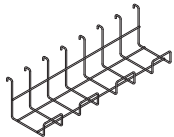

L'elettrificazione verticale può essere realizzata tramite vertebre in policarbonato traslucido collegate al portacavi (tipologia A), con guaine raccogli-cavi (tipologia B) oppure attraverso la cavità presente all'interno del basamento a diamante (tipologia C).

A

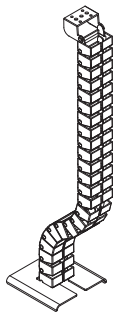

B

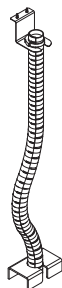

C

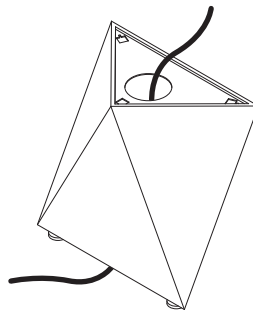

07

Note verdi

Tutti i pannelli di particelle, utilizzati nella produzione dei nostri mobili, sono FSC 100%, rispondono a quanto previsto dalla certificazione CARB 2 e soddisfano i requisiti LEED per il credito IEQ 4.5 per i materiali a basse emissioni ed i requisiti ANSI/BIFMA X7.1-2011.

ERACLE

is a top level executive collection featuring an aluminium profile frame combined with faceted legs faced with aluminium sheet.

01

Desks

Legs are in anodised aluminium sheet-faced phenolic plywood or leather covered. The legs are made with the folding process that gives them a faceted shape.

The following desk variants are available:

- with four corner legs (A);
- with two panelled legs (B);
- with two corner legs and a diamond-shaped base (C).

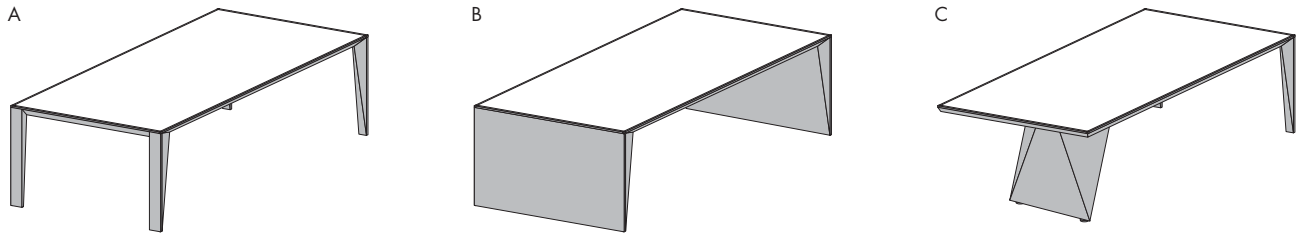

The desk top frame is in triangular section anodised extruded aluminium and measures 116x79.5 mm.

Work tops are available in the following finishes:

- 18 mm thick melamine faced edged with 2 mm ABS;
- 18 mm thick veneered with 2 mm wood edge;
- melamine faced and covered in 2 mm leather with visible stitching;
- 6 mm thick porcelain stoneware (backed by a 12 mm thick melamine-faced panel);
- 8 mm thick extra clear glass, embossed with water-based paint on the lower part and if required with anti fingerprint treatment on the upper part.

The corner joints are in cast metal.

02

Return desk

The Eracle collection includes independent or linked return desks. The latter are linked to the desk structure by means of special metal brackets. Return desks have the same specifications as the desks.

03

Modesty panel

An 18 mm thick modesty panel, available in several finishes, can be fitted under the worktop.

- melamine faced;
- precomposed wood veneered;
- melamine faced and covered in 2mm leather with visible stitching;
- embossed.

04

Meeting tables

Meeting tables are square or rectangular and can be supplied with the following features:

- four corner legs (A);
- two bases (B);
- two corner legs and a diamond-shaped base (C).

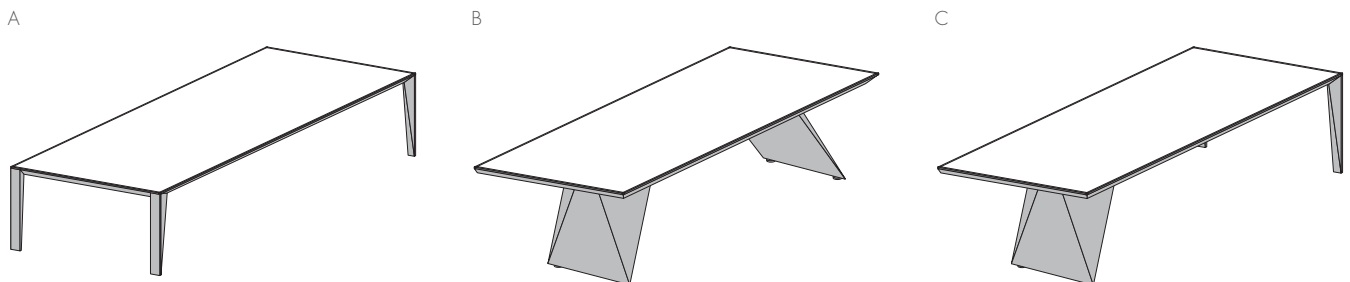

05

Coffee tables

Eracle includes H.400 mm coffee tables with corner legs and the same specifications as the desks.

06

Electrification

Desks and meeting tables can be provided with PVC wire management systems of different sizes and aluminium modular top access plates. On demand these elements can be placed to suit requirements.

Desks can be provided with a steel rod wire management tray secured to the frame.

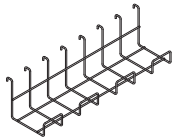

Vertical electrification can be provided with a translucent polycarbonate spine wire management system connected to the wire management tray (A), cable tidy sleeving (type B) or through the cavity in the diamond-shaped base (C).

A

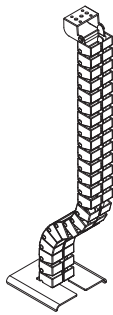

B



C

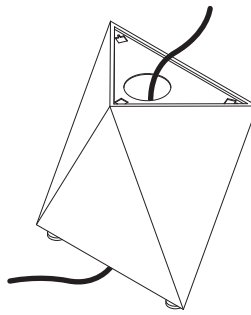

07

Green notes

All particle board panels used for our furniture are 100% FSC, comply with CARB 2 certification, and meet ANSI/BIFMA X7.1-2011 requirements and LEED requisites for IEQ 4.5 credits for low emission materials.

ERACLE

est une collection directionnelle de haut niveau caractérisée par un châssis en profil d'aluminium combiné avec piètements taillés revêtus en feuille d'aluminium.

01

Bureaux

Les piètements sont réalisés en multiplex phénolique et revêtus avec une feuille d'aluminium anodisé ou en cuir. Les piètements sont produits avec un processus particulier dénommé "folding" qui leur confère une forme à facettes.

Les bureaux sont disponibles dans les variantes suivantes:

- avec quatre piètements d'angle (typologie A);
- avec deux piètements lambrissés (typologie B);
- avec deux piètements d'angle et une base à diamant (typologie C).

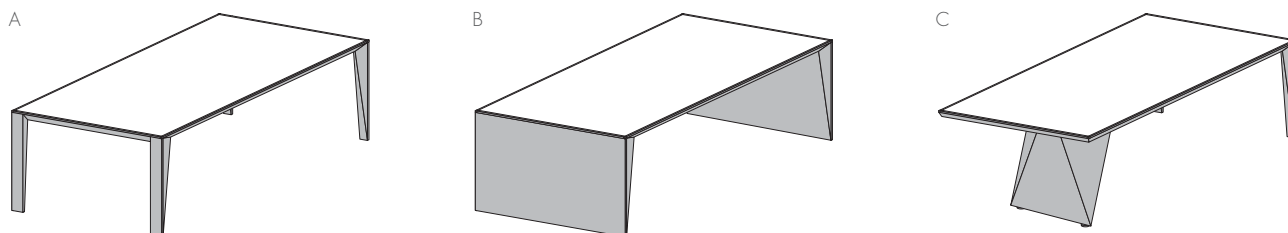

Le châssis qui accueille le plateau du bureau est réalisé avec de l'aluminium anodisé extrudé à section triangulaire de dimensions 116x79,5 mm.

Les plateaux sont disponibles en:

- mélaminé ennobli, épaisseur 18 mm avec chant ABS de 2 mm;
 - plaqué, épaisseur 18 mm avec chant bois de 1 mm;
 - mélaminé ennobli, revêtu de cuir de 2 mm d'épaisseur avec coutures visibles;
 - grès porcelainé, épaisseur 6 mm (soutenu par un panneau mélaminé ennobli, épaisseur 12 mm);
 - verre extra-clair épaisseur 8 mm, gaufré à l'eau sur la partie inférieure et traitement éventuel anti-empreinte sur la partie supérieure.
- Les jonctions d'angle sont réalisées en alliage de zamak.

02

Retours

La collection Eracle est enrichie par des retours indépendants ou accrochés à la structure du bureau au moyen d'une bride métallique spéciale. Les retours sont réalisés avec les mêmes caractéristiques que celles des bureaux.

03

Voile de fond

Il est possible de fixer au châssis un voile de fond d'une épaisseur de 18mm disponible dans les finitions suivantes :

- mélaminé ennobli;
- plaqué en essence de bois précomposé;
- mélaminé ennobli, revêtu de cuir de 2 mm d'épaisseur avec coutures visibles;
- gaufré.

04

Tables de réunion

Les tables de réunion ont une forme carrée ou rectangulaire et il est possible de choisir parmi les différentes typologies:

- avec quatre piètements d'angle (typologie A);
- avec deux bases (typologie B);
- avec deux piètements d'angle et une base à diamant (typologie C).

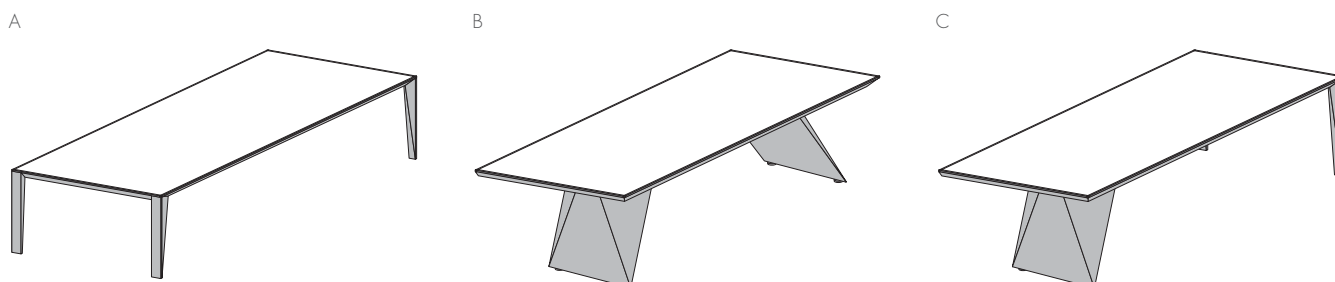

05

Tables basses

Eracle dispose de tables basses H.400 mm à piètements d'angle avec les mêmes caractéristiques que celles des bureaux.

06

Électrification

Les plateaux des bureaux et les tables de réunion peuvent être dotés de passe-câbles en PVC de différentes dimensions et de top access modulaires réalisés en aluminium. Ces éléments sont positionnables sur demande.

Pour l'électrification, il est possible d'appliquer aux bureaux une goulotte en fil d'acier fixée au châssis.

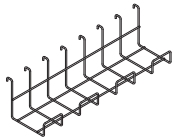

L'électrification verticale peut être réalisée avec des vertèbres en polycarbonate translucide reliées aux goulottes (typologie A), gaines (typologie B) ou à travers la cavité présente à l'intérieur de la base à diamant (typologie C).

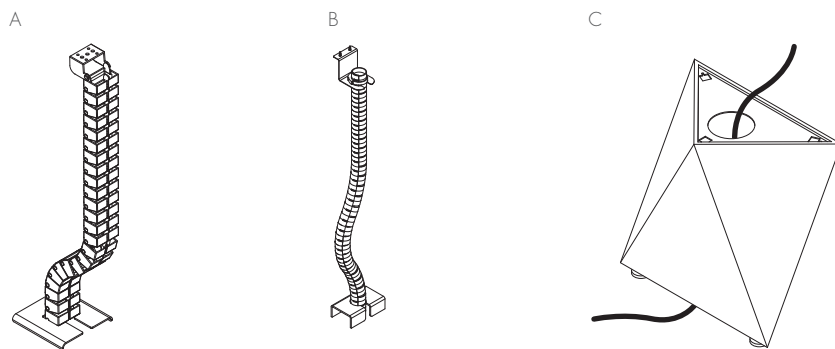

07

Remarques écologiques

Tous les panneaux de particules utilisés dans la production de nos meubles sont certifiés 100% FSC, répondent aux critères de la certification CARB 2 et satisfont les exigences LEED requises pour le crédit IEQ 4.5 concernant les matériaux à basses émissions et ANSI/BIFMA X7.1-2011.

ERACLE

es una colección direccional de alto nivel caracterizada por un marco con perfil de aluminio combinado con patas labradas revestidas con chapa de aluminio.

01

Escritorios

Las patas están realizadas con material fenólico multicapa y revestidas con una chapa de aluminio anodizado o tapizadas de cuero. Las patas se producen mediante un proceso particular denominado "folding", que confiere a la pata una forma labrada.

Los escritorios están disponibles en las variantes siguientes:

- con cuatro patas angulares (tipo A);
- con dos patas revestidas de paneles (tipo B);
- con dos patas angulares y una base en forma de diamante (tipo C).

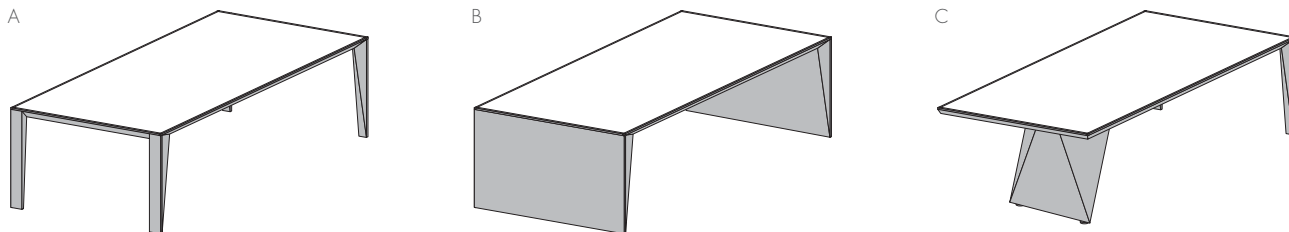

El marco que acoge el tablero de escritorio está realizado en aluminio extruido anodizado de 116x79,5 mm de sección triangular.

Los tableros de trabajo están disponibles en:

- madera revestida de melamina, de 18 mm de espesor con borde en ABS de 2 mm;
 - madera chapada, de 18 mm de espesor con borde de madera de 1 mm;
 - madera revestida de melamina, tapizada de cuero de 2 mm con costuras a la vista;
 - gres porcelánico, de 6 mm de espesor (soportado por un panel de madera revestida de melamina, de 12 mm de espesor);
 - cristal extraclaro de 8 mm de espesor, gofrado al agua en la parte inferior y posible tratamiento antihuella en la parte superior.
- Las uniones angulares están realizadas en aleación de zamak.

02

Estantes para computadores

La colección Eracle está equipada con estantes para computadores independientes o enganchados. Este último tipo se engancha en la estructura del escritorio, mediante una abrazadera metálica. Los estantes para computadores están realizados con las mismas características que los escritorios.

03

Modesty (panel inferior frontal)

En el marco puede fijarse un panel inferior frontal de 18 mm de espesor, también el mismo disponible en distintos acabados:

- madera revestida de melamina;
- madera chapada precompuesta;
- madera revestida de melamina, tapizada de cuero de 2 mm con costuras a la vista;
- gofrado.

04

Mesas de reunión

Las mesas de reunión tienen una forma cuadrada o rectangular y es posible elegir entre los tipos siguientes:

- con cuatro patas angulares (tipo A);
- con dos bases (tipo B);
- con dos patas angulares y una base en forma de diamante (tipo C).

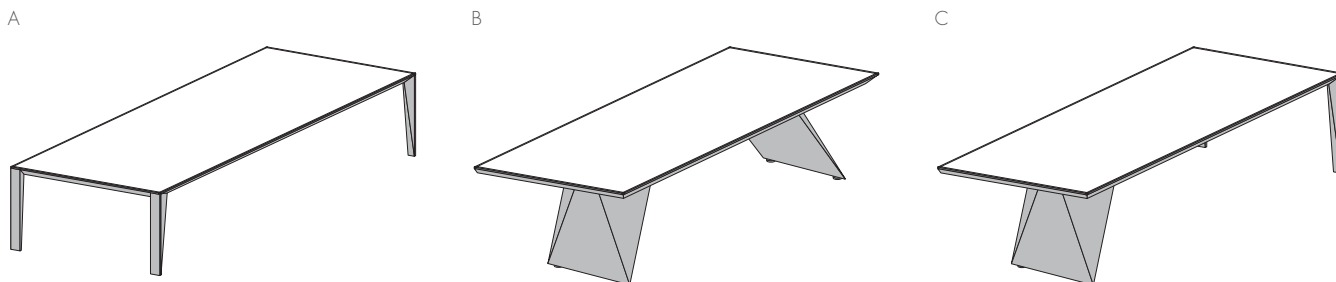

05

Mesitas

Eracle dispone de mesitas de 400 mm de alto con patas angulares con las mismas especificaciones indicadas para los escritorios.

06

Electrificación

Los tableros de escritorio y las mesas de reunión pueden equiparse con pasacables de PVC de distintas dimensiones y con canaletas modulares para cables realizadas en aluminio. Estos elementos son posicionables bajo pedido.

Para la electrificación es posible aplicar en los escritorios un portacables en alambre de acero fijado en el marco.

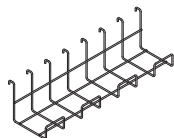

La electrificación vertical puede realizarse con vértebras de policarbonato translúcido fijadas en el portacables (tipo A), con cubiertas flexibles (tipo B) o mediante los huecos que se encuentran en el interior de la base en forma de diamante (tipo C).

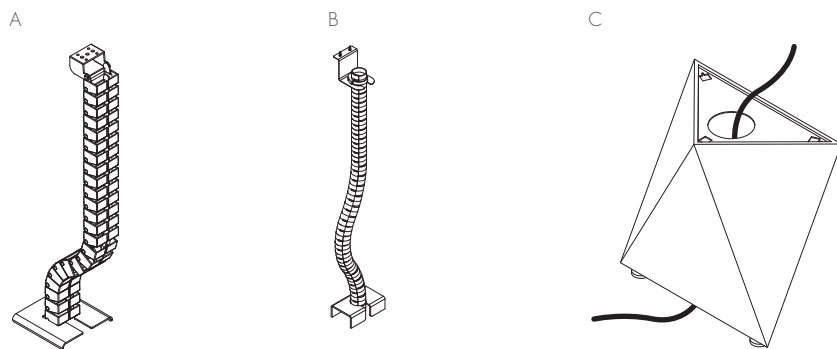

07

Notas ecológicas

Todos los paneles de partículas, utilizados en la producción de nuestros muebles, son FSC 100%, están conformes con lo previsto por la certificación CARB 2 y satisfacen los requisitos LEED para el crédito IEQ 4.5 para los materiales de bajas emisiones y los requisitos ANSI/BIFMA X7.1-2011.

MEL

Melaminico

Melamine | Mélaminé | Melaminico



MB

Bianco rigato
Rippled effect white
Blanc avec rayures en sérigraphie
Blanco rayado



MG

Grigio rigato
Rippled effect grey
Gris avec rayures en sérigraphie
Gris rayado



MF

Nichel
Nickel
Nickel
Niquel



MZ

Cacao
Cacao
Cacao
Cacao



MN

Bianco
White
Blanc
Blanco



MT

Talco
Talco
Talco
Talco



MJ

Ocra
Ochre
Ocre
Ocre



MK

Safari
Safari
Safari
Safari



MI

Noisette
Noisette
Noisette
Noisette

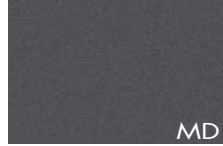

MD

Ardesia
Ardesia
Ardesia
Pizarra

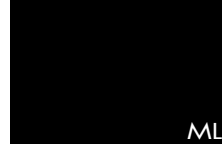

ML

Nero
Black
Noir
Negro



MC

Rovere chiaro
Light oak
Chêne clair
Roble claro



MY

Rovere americano
American oak
Chêne américain
Roble americano



ME

Rovere grigio
Grey oak
Chêne gris
Roble gris



MM

Rovere moro
Dark oak
Chêne foncé
Roble oscuro



MP

Noce chiaro
Light walnut
Noyer clair
Nogal claro



MO

Noce Canaletto
Canaletto Walnut
Noyer Canaletto
Nogal Canaletto

Varianti scrivanie e tavoli

Variants desks and tables | Variantes bureaux et tables | Opciones mesas y mesas de juntas

COPL Colore piano
Top finishing
Finition plateau
Acabado sobre

COMD Colore modesty panel
Modesty panel finishing
Finition voile de fond
Acabado faldón

Le finiture contenute nel presente listino sono puramente indicative e non sono di riferimento per le forniture del prodotto.

Due to the printing process, finishes shown in this price list are for illustration only. The finish on the final item may differ slightly from the printed illustration.

Les finitions contenues dans ce tarif ne sont pas contractuelles - les photos ne pouvant rendre la parfaite réalité.

Los acabados contenidos en esta lista de precios son puramente indicativos y no son de referencia para los suministros del producto.

Finishes | Finitions | Acabados

GOF

Goffrato

Embossed | Gaufré | Lacado



Bianco
White
Blanc
Blanco

Argento
Silver
Argent
Plata

Grigio scuro
Dark grey
Gris foncé
Gris oscuro

Noisette
Noisette
Noisette
Noisette

Ardesia
Ardesia
Ardesia
Pizarra

Moka
Mocha
Moka
Cafe



Nero
Black
Nair
Negro

Arancione
Orange
Orange
Naranja

Rosso "F"
Red "F"
Rouge "F"
Rojo "F"

Rubino
Ruby
Rubis
Rubi

Indaco
Indigo
Indigo
Azul Indigo

Azzurro
Blue
Bleu
Azul



Verde
Green
Vert
Verde

Cedro
Lime green
Vert Cédrat
Verde Cedro

Varianti scrivanie e tavoli

Variants desks and tables | Variantes bureaux et tables | Opciones mesas y mesas de juntas

COMD Colore modesty panel

Modesty panel finishing
Finition voile de fond
Acabado faldón

GRES

Gres

Porcelain tiles | Grès cérame | Gres porcelánico



Basalt
Basalt
Basalt
Basalt

Calacatta
Calacatta
Calacatta
Calacatta

Pulpis
Pulpis
Pulpis
Pulpis

Corten
Corten
Corten
Corten

Varianti scrivanie e tavoli

Variants desks and tables | Variantes bureaux et tables | Opciones mesas y mesas de juntas

COPL Colore piano

Top finishing
Finition plateau
Acabado sobre

Le finiture contenute nel presente listino sono puramente indicative e non sono di riferimento per le forniture del prodotto.

Due to the printing process, finishes shown in this price list are for illustration only. The finish on the final item may differ slightly from the printed illustration.
Les finitions contenues dans ce tarif ne sont pas contractuelles - les photos ne pouvant rendre la parfaite réalité.

Los acabados contenidos en esta lista de precios son puramente indicativos y no son de referencia para los suministros del producto.

Finishes | Finitions | Acabados

LGN

Legno

Wood | Bois | Madera

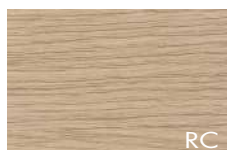

Rovere chiaro
Light oak
Chêne clair
Roble claro

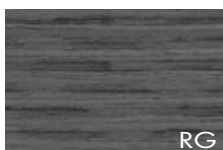

Rovere grigio fumo
Smoke grey oak
Chêne gris de fumée
Roble gris humo



Rovere moro
Dark oak
Chêne foncé
Roble oscuro



Noce Canaletto
Canaletto Walnut
Noyer Canaletto
Nogal Canaletto

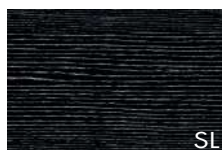

Ebano Silver
Silver ebony
Ebony Silver
Ebano plata



Ebano Makassar
Makassar ebony
Ebony Makassar
Ebano Makassar



Noce termocotto
Heat-treated walnut
Noyer thermo traité
Nogal termotratado

Varianti scrivanie e tavoli

Variants desks and tables | Variantes bureaux et tables | Opciones mesas y mesas de juntas

COPL Colore piano
Top finishing
Finition plateau
Acabado sobre

COMD Colore modesty panel
Modesty panel finishing
Finition voile de fond
Acabado faldón

Le finiture contenute nel presente listino sono puramente indicative e non sono di riferimento per le forniture del prodotto.

Due to the printing process, finishes shown in this price list are for illustration only. The finish on the final item may differ slightly from the printed illustration.

Les finitions contenues dans ce tarif ne sont pas contractuelles - les photos ne pouvant rendre la parfaite réalité.

Los acabados contenidos en esta lista de precios son puramente indicativos y no son de referencia para los suministros del producto.

Finishes | Finitions | Acabados

VTR **NFG**

Vetro
Glass | Verre | Vidrio

Vetro antimpronta
Antifinger glass | Verre antitaches | Vidrio anti-huella



Bianco
White
Blanc
Blanco

Argento
Silver
Argent
Plata

Grigio scuro
Dark grey
Gris foncé
Gris oscuro

Noisette
Noisette
Noisette
Noisette

Ardesia
Ardesia
Ardesia
Pizarra

Moka
Mocha
Moka
Cafe



Nero
Black
Nair
Negro

Arancione
Orange
Orange
Naranja

Rosso "F"
Red "F"
Rouge "F"
Rojo "F"

Rubino
Ruby
Rubis
Rubi

Indaco
Indigo
Indigo
Azul Indigo

Azzurro
Blue
Bleu
Azul



Verde
Green
Vert
Verde

Cedro
Lime green
Vert Cédrat
Verde Cedro

Varianti scrivanie e tavoli

Variants desks and tables | Variantes bureaux et tables | Opciones mesas y mesas de juntas

COPL **Colore piano**
Top finishing
Finition plateau
Acabado sobre

Le finiture contenute nel presente listino sono puramente indicative e non sono di riferimento per le forniture del prodotto.
Due to the printing process, finishes shown in this price list are for illustration only. The finish on the final item may differ slightly from the printed illustration.
Les finitions contenues dans ce tarif ne sont pas contractuelles - les photos ne pouvant rendre la parfaite réalité.
Los acabados contenidos en esta lista de precios son puramente indicativos y no son de referencia para los suministros del producto.

Finishes | Finitions | Acabados

CUO

Cuoio

Leather | Cuir | Cuero

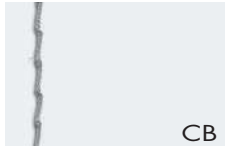

Bianco
White
Blanc
Blanco

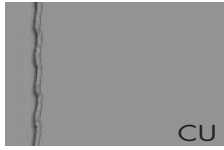

Alluminio
Aluminium
Aluminium
Aluminio



Nero
Black
Noir
Negro



Testa di moro
Brown
Tete de maure
Marron oscuro



Caramello
Caramel
Caramel
Caramelo



Arancione
Orange
Orange
Naranja



Indaco
Indigo
Indigo
Azul Indigo

Varianti scrivanie e tavoli

Variants desks and tables | Variantes bureaux et tables | Opciones mesas y mesas de juntas

COPL **Colore piano**
Top finishing
Finition plateau
Acabado sobre

COTL **Colore telaio**
Frame colour
Couleur cadre
Acabado marco

COMD **Colore modesty panel**
Modesty panel finishing
Finition voile de fond
Acabado faldón

COGM **Colore gamba**
Leg finishing
Finition pied
Acabado pata

BR

Brill

Brill | Brill | Brill



Brill
Brill
Brill
Brill

Varianti accessori

Variants accessories | Options accessoires | Opciones accesorios

COFL **Colore Magic-Top**
Magic-Top colour
Couleur Magic-Top
Acabado de Magic-Top

Le finiture contenute nel presente listino sono puramente indicative e non sono di riferimento per le forniture del prodotto.

Due to the printing process, finishes shown in this price list are for illustration only. The finish on the final item may differ slightly from the printed illustration.

Les finitions contenues dans ce tarif ne sont pas contractuelles - les photos ne pouvant rendre la parfaite réalité.

Los acabados contenidos en esta lista de precios son puramente indicativos y no son de referencia para los suministros del producto.

Finishes | Finitions | Acabados

AL

Alluminio

Aluminium | Aluminium | Aluminio



Alluminio
Aluminium
Aluminium
Aluminio

Varianti scrivanie e tavoli

Variants desks and tables | Variantes bureaux et tables | Opciones mesas y mesas de juntas

COTL **Colore telaio**
Frame colour
Couleur cadre
Acabado marco

COGM **Colore gamba**
Leg finishing
Finition pied
Acabado pata

Basamenti
Bases
Base de support
Base central

Varianti accessori

Variants accessories | Options accessoires | Opciones accesorios

COFL **Colore Magic-Top**
Magic-Top colour
Couleur Magic-Top
Acabado de Magic-Top

CRM

Inox lucido

Stainless Steel | Inox brossé poli | Acero inoxidable



Inox lucido
Stainless Steel
Inox brossé poli
Acero inoxidable

PLA

Plastica

Plastic | Plastique | Plástico



Bianco
White
Blanc
Blanco



Grigio
Grey
Gris
Gris

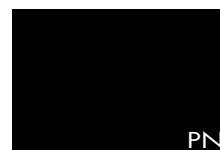

Nero
Black
Noir
Negro

Varianti accessori

Variants accessories | Options accessoires | Opciones accesorios

COAC **Colore passacavi**
Grommet finishing
Finition passecables
Acabado pasacables

Le finiture contenute nel presente listino sono puramente indicative e non sono di riferimento per le forniture del prodotto.

Due to the printing process, finishes shown in this price list are for illustration only. The finish on the final item may differ slightly from the printed illustration.

Les finitions contenues dans ce tarif ne sont pas contractuelles - les photos ne pouvant rendre la parfaite réalité.

Los acabados contenidos en esta lista de precios son puramente indicativos y no son de referencia para los suministros del producto.

Scrivanie H. 73,4

Desks H. 73,4 | Bureaux H. 73,4 | Mesas H. 73,4

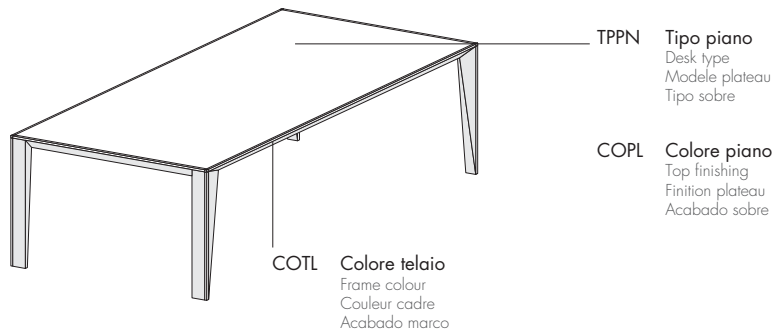

Disposizione cuciture su piani in cuoio

Sewing layout on leather desk-top - Schéma de coutures sur plateaux en cuir - Disposición de las costuras en sobre de mesa en cuero

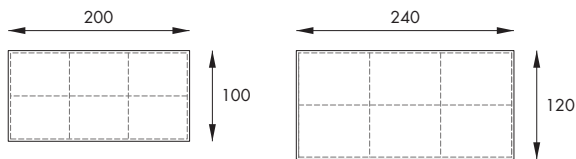

P2011



Scrivania P. 100

Desk D. 100
Bureau P. 100
Mesa P. 100

Struttura alluminio anodizzato

Structure anodised aluminium - Structures aluminium anodisé - Estructura aluminio anodizado

MEL	GOF	LGN	CUO	VTR	NFG	GRES
Melaminico	Goffrato	Legno	Cuoio	Vetro	Vetro antimpronta	Gres
Melamine	Embossed	Wood	Leather	Glass	Antifinger glass	Porcelain tiles
Méla miné	Gaufré	Bois	Cuir	Verre	Verre antitaches	Grès cérame
Melaminico	Lacado	Madera	Cuero	Vidrio	Vidrio anti-huella	Gres porcelánico

L P H

P20111020	200	100	73,4	2.474	-	2.895	3.408	-	-	-
-----------	-----	-----	------	-------	---	-------	-------	---	---	---

Struttura rivestita in cuoio

Structure upholstered in leather - Structure revêtue en cuir - Estructura revestida en cuero

MEL	GOF	LGN	CUO	VTR	NFG	GRES
-----	-----	-----	-----	-----	-----	------

L P H

P20111020	200	100	73,4	-	-	4127	4640	-	-	-
-----------	-----	-----	------	---	---	------	------	---	---	---

P2011

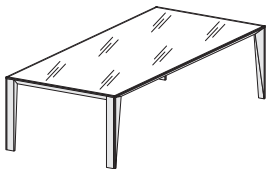

Scrivania P. 100

Desk D. 100
Bureau P. 100
Mesa P. 100

Struttura alluminio anodizzato

Structure anodised aluminium - Structures aluminium anodisé - Estructura aluminio anodizado

MEL	GOF	LGN	CUO	VTR	NFG	GRES
Melaminico	Goffrato	Legno	Cuoio	Vetro	Vetro antimpronta	Gres
Melamine	Embossed	Wood	Leather	Glass	Antifinger glass	Porcelain tiles
Méla miné	Gaufré	Bois	Cuir	Verre	Verre antitaches	Grès cérame
Melaminico	Lacado	Madera	Cuero	Vidrio	Vidrio anti-huella	Gres porcelánico

L P H

P20111020V	200	100	73,4	-	-	-	-	3.256	3.548	-
------------	-----	-----	------	---	---	---	---	-------	-------	---

Struttura rivestita in cuoio

Structure upholstered in leather - Structure revêtue en cuir - Estructura revestida en cuero

MEL	GOF	LGN	CUO	VTR	NFG	GRES
-----	-----	-----	-----	-----	-----	------

L P H

P20111020V	200	100	73,4	-	-	-	-	4488	4780	-
------------	-----	-----	------	---	---	---	---	------	------	---

P2011



Scrivania P. 100

Desk D. 100
Bureau P. 100
Mesa P. 100

Struttura alluminio anodizzato

Structure anodised aluminium - Structures aluminium anodisé - Estructura aluminio anodizado

MEL	GOF	LGN	CUO	VTR	NFG	GRES
Melaminico	Goffrato	Legno	Cuoio	Vetro	Vetro antimpronta	Gres
Melamine Mélaminé Melaminico	Embossed Gaufré Lacado	Wood Bois Madera	Leather Cuir Cuero	Glass Verre Vidrio	Antifinger glass Verre antitaches Vidrio anti-huella	Porcelain tiles Grès cérame Gres porcelánico

	L	P	H						
P20111020J	200	100	73,4	-	-	-	-	-	3.898

Struttura rivestita in cuoio

Structure upholstered in leather - Structure revêtue en cuir - Estructura revestida en cuero

MEL	GOF	LGN	CUO	VTR	NFG	GRES
MEL	GOF	LGN	CUO	VTR	NFG	GRES

	L	P	H						
P20111020J	200	100	73,4	-	-	-	-	-	5130

P2011



Scrivania P. 120

Desk D. 120
Bureau P. 120
Mesa P. 120

Struttura alluminio anodizzato

Structure anodised aluminium - Structures aluminium anodisé - Estructura aluminio anodizado

MEL	GOF	LGN	CUO	VTR	NFG	GRES
Melaminico	Goffrato	Legno	Cuoio	Vetro	Vetro antimpronta	Gres
Melamine Mélaminé Melaminico	Embossed Gaufré Lacado	Wood Bois Madera	Leather Cuir Cuero	Glass Verre Vidrio	Antifinger glass Verre antitaches Vidrio anti-huella	Porcelain tiles Grès cérame Gres porcelánico

	L	P	H						
P20111224	240	120	73,4	2.610	-	3.206	3.926	-	-

Struttura rivestita in cuoio

Structure upholstered in leather - Structure revêtue en cuir - Estructura revestida en cuero

MEL	GOF	LGN	CUO	VTR	NFG	GRES
MEL	GOF	LGN	CUO	VTR	NFG	GRES

	L	P	H						
P20111224	240	120	73,4	-	-	4524	5244	-	-

P2011

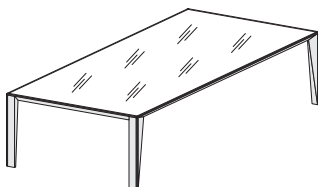

Scrivania P. 120

Desk D. 120
Bureau P. 120
Mesa P. 120

Struttura alluminio anodizzato

Structure anodised aluminium - Structures aluminium anodisé - Estructura aluminio anodizado

MEL	GOF	LGN	CUO	VTR	NFG	GRES
Melaminico	Goffrato	Legno	Cuoio	Vetro	Vetro antimpronta	Gres
Melamine Mélaminé Melaminico	Embossed Gaufré Lacado	Wood Bois Madera	Leather Cuir Cuero	Glass Verre Vidrio	Antifinger glass Verre antitaches Vidrio anti-huella	Porcelain tiles Grès cérame Gres porcelánico

	L	P	H						
P20111224V	240	120	73,4	-	-	-	-	3.723	4.134

Struttura rivestita in cuoio

Structure upholstered in leather - Structure revêtue en cuir - Estructura revestida en cuero

MEL	GOF	LGN	CUO	VTR	NFG	GRES
MEL	GOF	LGN	CUO	VTR	NFG	GRES

	L	P	H						
P20111224V	240	120	73,4	-	-	-	-	5041	5452

P2011



Scrivania P. 120

Desk D. 120
Bureau P. 120
Mesa P. 120

Struttura alluminio anodizzato

Structure anodised aluminium - Structures aluminium anodisé - Estructura aluminio anodizado

MEL	GOF	LGN	CUO	VTR	NFG	GRES
Melaminico	Goffrato	Legno	Cuoio	Vetro	Vetro antimpronta	Gres
Melamine	Embossed	Wood	Leather	Glass	Antifinger glass	Porcelain tiles
Méla miné	Gaufré	Bois	Cuir	Verre	Verre antitaches	Grès cérame
Melaminico	Lacado	Madera	Cuero	Vidrio	Vidrio anti-huella	Gres porcelánico

L P H

P20111224J	240	120	73,4	-	-	-	-	-	4.509
-------------------	-----	-----	------	---	---	---	---	---	-------

Struttura rivestita in cuoio

Structure upholstered in leather - Structure revêtue en cuir - Estructura revestida en cuero

MEL	GOF	LGN	CUO	VTR	NFG	GRES
MEL	GOF	LGN	CUO	VTR	NFG	GRES

L P H

P20111224J	240	120	73,4	-	-	-	-	-	5827
-------------------	-----	-----	------	---	---	---	---	---	------

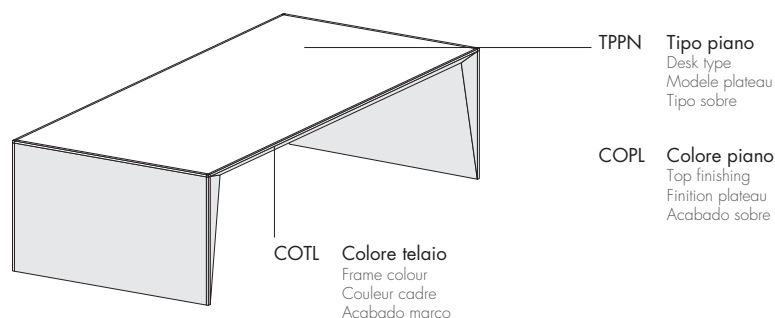

TPPN Tipo piano
Desk type
Modele plateau
Tipo sobre

COPL Colore piano
Top finishing
Finition plateau
Acabado sobre

COTL Colore telaio
Frame colour
Couleur cadre
Acabado marco

Disposizione cuciture su piani in cuoio

Sewing layout on leather desk-top - Schéma de coutures sur plateaux en cuir - Disposición de las costuras en sobre de mesa en cuero

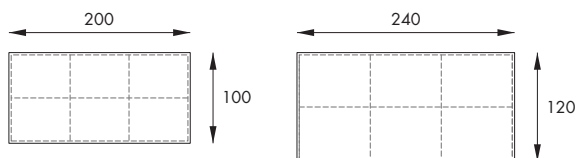

P201P

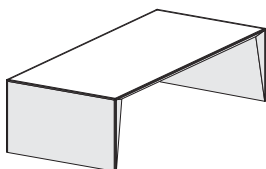

Scrivania P. 100

Desk D. 100
Bureau P. 100
Mesa P. 100

Struttura alluminio anodizzato

Structure anodised aluminium - Structures aluminium anodisé - Estructura aluminio anodizado

MEL	GOF	LGN	CUO	VTR	NFG	GRES
Melaminico	Goffrato	Legno	Cuoio	Vetro	Vetro antimpronta	Gres
Melamine	Embossed	Wood	Leather	Glass	Antifinger glass	Porcelain tiles
Méla miné	Gaufré	Bois	Cuir	Verre	Verre antitaches	Grès cérame
Melaminico	Lacado	Madera	Cuero	Vidrio	Vidrio anti-huella	Gres porcelánico

	L	P	H							
P201P1020	200	100	73,4	2.866	-	3.287	3.800	-	-	-

Struttura rivestita in cuoio

Structure upholstered in leather - Structure revêtue en cuir - Estructura revestida en cuero

MEL	GOF	LGN	CUO	VTR	NFG	GRES
-----	-----	-----	-----	-----	-----	------

	L	P	H							
P201P1020	200	100	73,4	-	-	4917	5430	-	-	-

P201P

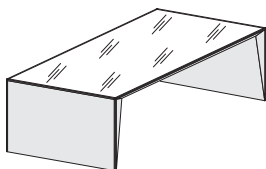

Scrivania P. 100

Desk D. 100
Bureau P. 100
Mesa P. 100

Struttura alluminio anodizzato

Structure anodised aluminium - Structures aluminium anodisé - Estructura aluminio anodizado

MEL	GOF	LGN	CUO	VTR	NFG	GRES
Melaminico	Goffrato	Legno	Cuoio	Vetro	Vetro antimpronta	Gres
Melamine	Embossed	Wood	Leather	Glass	Antifinger glass	Porcelain tiles
Méla miné	Gaufré	Bois	Cuir	Verre	Verre antitaches	Grès cérame
Melaminico	Lacado	Madera	Cuero	Vidrio	Vidrio anti-huella	Gres porcelánico

	L	P	H							
P201P1020V	200	100	73,4	-	-	-	-	3.648	3.940	-

Struttura rivestita in cuoio

Structure upholstered in leather - Structure revêtue en cuir - Estructura revestida en cuero

MEL	GOF	LGN	CUO	VTR	NFG	GRES
-----	-----	-----	-----	-----	-----	------

	L	P	H							
P201P1020V	200	100	73,4	-	-	-	-	5278	5570	-

P201P

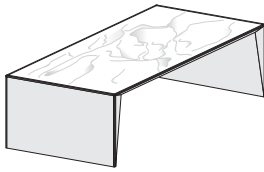

Scrivania P. 100

Desk D. 100
Bureau P. 100
Mesa P. 100

Struttura alluminio anodizzato

Structure anodised aluminium - Structures aluminium anodisé - Estructura aluminio anodizado

MEL	GOF	LGN	CUO	VTR	NFG	GRES
Melaminico	Goffrato	Legno	Cuoio	Vetro	Vetro antimpronta	Gres
Melamine Mélaminé Melaminico	Embossed Gaufré Lacado	Wood Bois Madera	Leather Cuir Cuero	Glass Verre Vidrio	Antifinger glass Verre antitaches Vidrio anti-huella	Porcelain tiles Grès cérame Gres porcelánico

L P H

P201P1020J	200	100	73,4	-	-	-	-	-	-	4.290
-------------------	-----	-----	------	---	---	---	---	---	---	-------

Struttura rivestita in cuoio

Structure upholstered in leather - Structure revêtue en cuir - Estructura revestida en cuero

MEL	GOF	LGN	CUO	VTR	NFG	GRES
-----	-----	-----	-----	-----	-----	------

L P H

P201P1020J	200	100	73,4	-	-	-	-	-	-	5920
-------------------	-----	-----	------	---	---	---	---	---	---	------

P201P

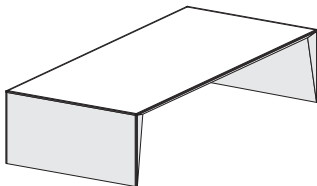

Scrivania P. 120

Desk D. 120
Bureau P. 120
Mesa P. 120

Struttura alluminio anodizzato

Structure anodised aluminium - Structures aluminium anodisé - Estructura aluminio anodizado

MEL	GOF	LGN	CUO	VTR	NFG	GRES
Melaminico	Goffrato	Legno	Cuoio	Vetro	Vetro antimpronta	Gres
Melamine Mélaminé Melaminico	Embossed Gaufré Lacado	Wood Bois Madera	Leather Cuir Cuero	Glass Verre Vidrio	Antifinger glass Verre antitaches Vidrio anti-huella	Porcelain tiles Grès cérame Gres porcelánico

L P H

P201P1224	240	120	73,4	3.248	-	3.844	4.564	-	-	-
------------------	-----	-----	------	-------	---	-------	-------	---	---	---

Struttura rivestita in cuoio

Structure upholstered in leather - Structure revêtue en cuir - Estructura revestida en cuero

MEL	GOF	LGN	CUO	VTR	NFG	GRES
-----	-----	-----	-----	-----	-----	------

L P H

P201P1224	240	120	73,4	-	-	5766	6486	-	-	-
------------------	-----	-----	------	---	---	------	------	---	---	---

P201P

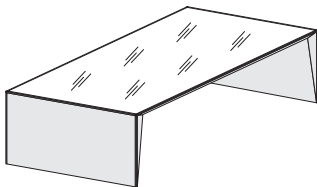

Scrivania P. 120

Desk D. 120
Bureau P. 120
Mesa P. 120

Struttura alluminio anodizzato

Structure anodised aluminium - Structures aluminium anodisé - Estructura aluminio anodizado

MEL	GOF	LGN	CUO	VTR	NFG	GRES
Melaminico	Goffrato	Legno	Cuoio	Vetro	Vetro antimpronta	Gres
Melamine Mélaminé Melaminico	Embossed Gaufré Lacado	Wood Bois Madera	Leather Cuir Cuero	Glass Verre Vidrio	Antifinger glass Verre antitaches Vidrio anti-huella	Porcelain tiles Grès cérame Gres porcelánico

L P H

P201P1224V	240	120	73,4	-	-	-	-	4.361	4.772	-
-------------------	-----	-----	------	---	---	---	---	-------	-------	---

Struttura rivestita in cuoio

Structure upholstered in leather - Structure revêtue en cuir - Estructura revestida en cuero

MEL	GOF	LGN	CUO	VTR	NFG	GRES
-----	-----	-----	-----	-----	-----	------

L P H

P201P1224V	240	120	73,4	-	-	-	-	6283	6694	-
-------------------	-----	-----	------	---	---	---	---	------	------	---

P201P

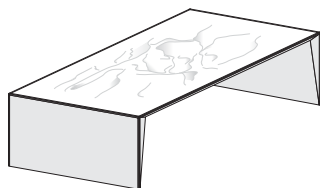

Scrivania P. 120

Desk D. 120
Bureau P. 120
Mesa P. 120

Struttura alluminio anodizzato

Structure anodised aluminium - Structures aluminium anodisé - Estructura aluminio anodizado

MEL	GOF	LGN	CUO	VTR	NFG	GRES
Melaminico	Goffrato	Legno	Cuoio	Vetro	Vetro antimpronta	Gres
Melamine	Embossed	Wood	Leather	Glass	Antifinger glass	Porcelain tiles
Méla miné	Gaufré	Bois	Cuir	Verre	Verre antitaches	Grès cérame
Melaminico	Lacado	Madera	Cuero	Vidrio	Vidrio anti-huella	Gres porcelánico

	L	P	H							
P201P1224J	240	120	73,4	-	-	-	-	-	-	5.147

Struttura rivestita in cuoio

Structure upholstered in leather - Structure revêtue en cuir - Estructura revestida en cuero

MEL	GOF	LGN	CUO	VTR	NFG	GRES

	L	P	H							
P201P1224J	240	120	73,4	-	-	-	-	-	-	7069

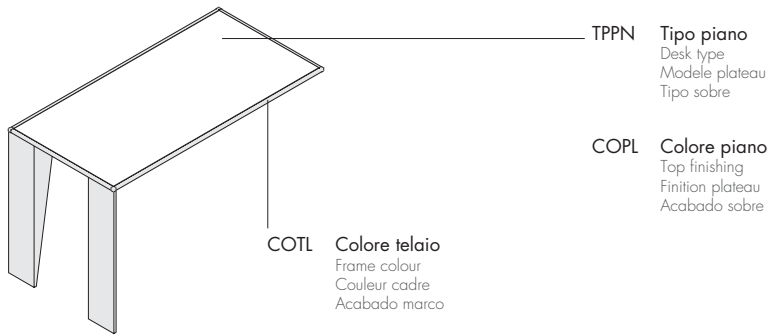

TPPN Tipo piano
Desk type
Modele plateau
Tipo sobre

COPL Colore piano
Top finishing
Finition plateau
Acabado sobre

COTL Colore telaio
Frame colour
Couleur cadre
Acabado marco

Disposizione cuciture su piani in cuoio

Sewing layout on leather desk-top - Schéma de coutures sur plateaux en cuir - Disposición de las costuras en sobre de mesa en cuero

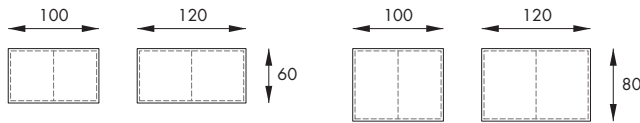

P2010

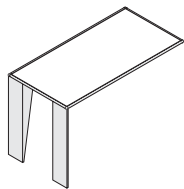

Dattilo agganciato P. 60

Hanging return D. 60
Retour accroché P. 60
Ala suspendida P. 60

Struttura alluminio anodizzato

Structure anodised aluminium - Structures aluminium anodisé - Estructura aluminio anodizado

MEL	GOF	LGN	CUO	VTR	NFG	GRES
Melaminico	Goffrato	Legno	Cuoio	Vetro	Vetro antimpronta	Gres
Melamine	Embossed	Wood	Leather	Glass	Antifinger glass	Porcelain tiles
Méla miné	Gaufré	Bois	Cuir	Verre	Verre antitaches	Grès cérame
Melaminico	Lacado	Madera	Cuero	Vidrio	Vidrio anti-huella	Gres porcelánico

	L	P	H						
P20100610	100	60	73,4	1.292	-	1.448	1.641	-	-
P20100612	120	60	73,4	1.410	-	1.603	1.832	-	-

E' obbligatorio aggiungere le staffe per dattilo agganciato pag.26

Must add brackets for hanging return page 26
Il est obligatoire d'ajouter la plaque pour retour accroché pag.26
Es obligatorio añadir los soportes para ala suspendida pag.26

Struttura rivestita in cuoio

Structure upholstered in leather - Structure revêtue en cuir - Estructura revestida en cuero

MEL	GOF	LGN	CUO	VTR	NFG	GRES
Melaminico	Goffrato	Legno	Cuoio	Vetro	Vetro antimpronta	Gres
Melamine	Embossed	Wood	Leather	Glass	Antifinger glass	Porcelain tiles
Méla miné	Gaufré	Bois	Cuir	Verre	Verre antitaches	Grès cérame
Melaminico	Lacado	Madera	Cuero	Vidrio	Vidrio anti-huella	Gres porcelánico

	L	P	H						
P20100610	100	60	73,4	-	-	2290	2483	-	-
P20100612	120	60	73,4	-	-	2449	2678	-	-

P2010

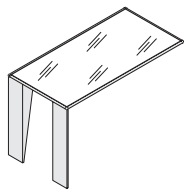

Dattilo agganciato P. 60

Hanging return D. 60
Retour accroché P. 60
Ala suspendida P. 60

Struttura alluminio anodizzato

Structure anodised aluminium - Structures aluminium anodisé - Estructura aluminio anodizado

MEL	GOF	LGN	CUO	VTR	NFG	GRES
Melaminico	Goffrato	Legno	Cuoio	Vetro	Vetro antimpronta	Gres
Melamine	Embossed	Wood	Leather	Glass	Antifinger glass	Porcelain tiles
Méla miné	Gaufré	Bois	Cuir	Verre	Verre antitaches	Grès cérame
Melaminico	Lacado	Madera	Cuero	Vidrio	Vidrio anti-huella	Gres porcelánico

	L	P	H						
P20100610V	100	60	73,4	-	-	-	-	1.588	1.698
P20100612V	120	60	73,4	-	-	-	-	1.766	1.899

E' obbligatorio aggiungere le staffe per dattilo agganciato pag.26

Must add brackets for hanging return page 26
Il est obligatoire d'ajouter la plaque pour retour accroché pag.26
Es obligatorio añadir los soportes para ala suspendida pag.26

Struttura rivestita in cuoio

Structure upholstered in leather - Structure revêtue en cuir - Estructura revestida en cuero

MEL	GOF	LGN	CUO	VTR	NFG	GRES
Melaminico	Goffrato	Legno	Cuoio	Vetro	Vetro antimpronta	Gres
Melamine	Embossed	Wood	Leather	Glass	Antifinger glass	Porcelain tiles
Méla miné	Gaufré	Bois	Cuir	Verre	Verre antitaches	Grès cérame
Melaminico	Lacado	Madera	Cuero	Vidrio	Vidrio anti-huella	Gres porcelánico

	L	P	H						
P20100610V	100	60	73,4	-	-	-	-	2430	2540
P20100612V	120	60	73,4	-	-	-	-	2612	2745

P2010

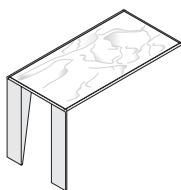

Dattilo agganciato P. 60

Hanging return D. 60
Retour accroché P. 60
Ala suspendida P. 60

Struttura alluminio anodizzato

Structure anodised aluminium - Structures aluminium anodisé - Estructura aluminio anodizado

MEL	GOF	LGN	CUO	VTR	NFG	GRES
Melaminico	Goffrato	Legno	Cuoio	Vetro	Vetro antimpronta	Gres
Melamine Mélaminé Melaminico	Embossed Gaufré Lacado	Wood Bois Madera	Leather Cuir Cuero	Glass Verre Vidrio	Antifinger glass Verre antitaches Vidrio anti-huella	Porcelain tiles Grès cérame Gres porcelánico
	L	P	H			
P20100610J	100	60	73,4	-	-	2.018
P20100612J	120	60	73,4	-	-	2.194

E' obbligatorio aggiungere le staffe per dattilo agganciato pag.26

Must add brackets for hanging return page 26
Il est obligatoire d'ajouter la plaque pour retour accroché pag.26
Es obligatorio añadir los soportes para ala suspendida pag.26

Struttura rivestita in cuoio

Structure upholstered in leather - Structure revêtue en cuir - Estructura revestida en cuero

MEL	GOF	LGN	CUO	VTR	NFG	GRES
	L	P	H			
P20100610J	100	60	73,4	-	-	2860
P20100612J	120	60	73,4	-	-	3040

P2010

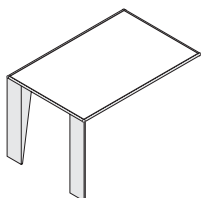

Dattilo agganciato P. 80

Hanging return D. 80
Retour accroché P. 80
Ala suspendida P. 80

Struttura alluminio anodizzato

Structure anodised aluminium - Structures aluminium anodisé - Estructura aluminio anodizado

MEL	GOF	LGN	CUO	VTR	NFG	GRES
Melaminico	Goffrato	Legno	Cuoio	Vetro	Vetro antimpronta	Gres
Melamine Mélaminé Melaminico	Embossed Gaufré Lacado	Wood Bois Madera	Leather Cuir Cuero	Glass Verre Vidrio	Antifinger glass Verre antitaches Vidrio anti-huella	Porcelain tiles Grès cérame Gres porcelánico
	L	P	H			
P20100810	100	80	73,4	1.422	-	1.633 1.892 - - -
P20100812	120	80	73,4	1.493	-	1.738 2.054 - - -

E' obbligatorio aggiungere le staffe per dattilo agganciato pag.26

Must add brackets for hanging return page 26
Il est obligatoire d'ajouter la plaque pour retour accroché pag.26
Es obligatorio añadir los soportes para ala suspendida pag.26

Struttura rivestita in cuoio

Structure upholstered in leather - Structure revêtue en cuir - Estructura revestida en cuero

MEL	GOF	LGN	CUO	VTR	NFG	GRES
	L	P	H			
P20100810	100	80	73,4	-	-	2479 2738 - - -
P20100812	120	80	73,4	-	-	2645 2961 - - -

P2010

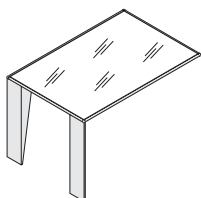

Dattilo agganciato P. 80

Hanging return D. 80
Retour accroché P. 80
Ala suspendida P. 80

Struttura alluminio anodizzato

Structure anodised aluminium - Structures aluminium anodisé - Estructura aluminio anodizado

MEL	GOF	LGN	CUO	VTR	NFG	GRES
Melaminico	Goffrato	Legno	Cuoio	Vetro	Vetro antimpronta	Gres
Melamine Mélaminé Melaminico	Embossed Gaufré Lacado	Wood Bois Madera	Leather Cuir Cuero	Glass Verre Vidrio	Antifinger glass Verre antitaches Vidrio anti-huella	Porcelain tiles Grès cérame Gres porcelánico
	L	P	H			
P20100810V	100	80	73,4	-	-	1.814 1.961 -
P20100812V	120	80	73,4	-	-	1.963 2.139 -

E' obbligatorio aggiungere le staffe per dattilo agganciato pag.26

Must add brackets for hanging return page 26
Il est obligatoire d'ajouter la plaque pour retour accroché pag.26
Es obligatorio añadir los soportes para ala suspendida pag.26

Struttura rivestita in cuoio

Structure upholstered in leather - Structure revêtue en cuir - Estructura revestida en cuero

MEL	GOF	LGN	CUO	VTR	NFG	GRES
	L	P	H			
P20100810V	100	80	73,4	-	-	2660 2807 -
P20100812V	120	80	73,4	-	-	2870 3046 -

P2010

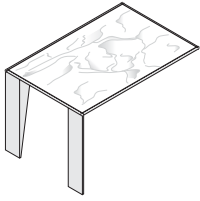

Dattilo agganciato P. 80

Hanging return D. 80
Retour accroché P. 80
Ala suspendida P. 80

Struttura alluminio anodizzato

Structure anodised aluminium - Structures aluminium anodisé - Estructura aluminio anodizado

MEL	GOF	LGN	CUO	VTR	NFG	GRES
Melaminico	Goffrato	Legno	Cuoio	Vetro	Vetro antimpronta	Gres
Melamine Mélaminé Melaminico	Embossed Gaufré Lacado	Wood Bois Madera	Leather Cuir Cuero	Glass Verre Vidrio	Antifinger glass Verre antitaches Vidrio anti-huella	Porcelain tiles Grès cérame Gres porcelánico

	L	P	H						
P20100810J	100	80	73,4	-	-	-	-	-	2.241
P20100812J	120	80	73,4	-	-	-	-	-	2.387

E' obbligatorio aggiungere le staffe per dattilo agganciato pag.26

Must add brackets for hanging return page 26

Il est obligatoire d'ajouter la plaque pour retour accroché pag.26

Es obligatorio añadir los soportes para ala suspendida pag.26

Struttura rivestita in cuoio

Structure upholstered in leather - Structure revêtue en cuir - Estructura revestida en cuero

MEL	GOF	LGN	CUO	VTR	NFG	GRES
P20100810J	100	80	73,4	-	-	3087
P20100812J	120	80	73,4	-	-	3294

P2001

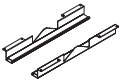

Staffe per dattilo agganciato

Brackets for hanging return
Plaque pour retour accroché
Soportes para ala suspendida

EPX						
Metallo						
Metal						
Metal						
Metal						

	L	P	H	
P2001100	100	-	-	388
P2001120	120	-	-	388

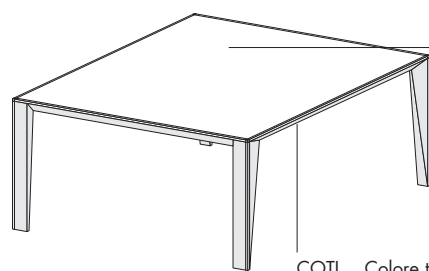

TPPN **Tipo piano**
Desk type
Modele plateau
Tipo sobre

COPL **Colore piano**
Top finishing
Finition plateau
Acabado sobre

COTL **Colore telaio**
Frame colour
Couleur cadre
Acabado marco

Configurazione piani in legno

Wooden tops configuration - Configuration plateaux en ébénisterie - Configuración sobres de madera

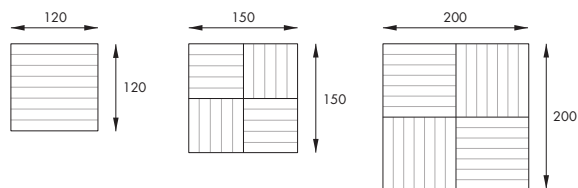

Disposizione cuciture su piani in cuoio

Sewing layout on leather desk-top - Schéma de coutures sur plateaux en cuir - Disposición de las costuras en sobre de mesa en cuero

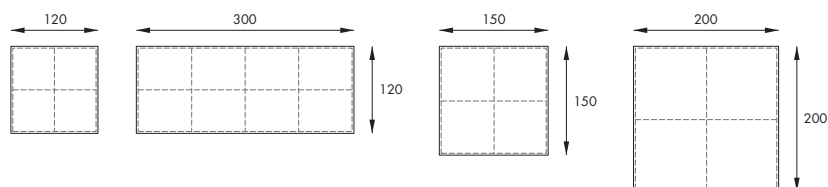

P2011



Tavolo riunione quadrato P. 120

Square meeting table D. 120
Table de réunion carré P. 120
Mesa de juntas cuadrada P. 120

Struttura alluminio anodizzato

Structure anodised aluminium - Structures aluminium anodisé - Estructura aluminio anodizado

MEL	GOF	LGN	CUO	VTR	NFG	GRES
Melaminico	Goffrato	Legno	Cuoio	Vetro	Vetro antimpronta	Gres
Melamine	Embossed	Wood	Leather	Glass	Antifinger glass	Porcelain tiles
Méla miné	Gaufré	Bois	Cuir	Verre	Verre antitaches	Grès cérame
Melaminico	Lacado	Madera	Cuero	Vidrio	Vidrio anti-huella	Gres porcelánico

	L	P	H						
P20111212	120	120	73,4	2.362	-	2.633	3.137	-	-

Struttura rivestita in cuoio

Structure upholstered in leather - Structure revêtue en cuir - Estructura revestida en cuero

	L	P	H	MEL	GOF	LGN	CUO	VTR	NFG	GRES
P20111212	120	120	73,4	-	-	3736	4240	-	-	-

Tavoli riunione H. 73,4

Meeting tables H. 73,4 | Tables de réunion H. 73,4 | Mesas de juntas H. 73,4

P2011

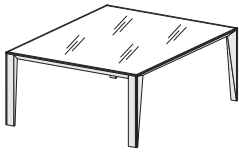

Tavolo riunione quadrato P. 120

Square meeting table D. 120
Table de réunion carré P. 120
Mesa de juntas cuadrada P. 120

Struttura alluminio anodizzato

Structure anodised aluminium - Structures aluminium anodisé - Estructura aluminio anodizado

MEL	GOF	LGN	CUO	VTR	NFG	GRES
Melaminico	Goffrato	Legno	Cuoio	Vetro	Vetro antimpronta	Gres
Melamine Mélaminé Melaminico	Embossed Gaufré Lacado	Wood Bois Madera	Leather Cuir Cuero	Glass Verre Vidrio	Antifinger glass Verre antitaches Vidrio anti-huella	Porcelain tiles Grès cérame Gres porcelánico

L P H

P20111212V 120 120 73,4

Struttura rivestita in cuoio

Structure upholstered in leather - Structure revêtue en cuir - Estructura revestida en cuero

MEL	GOF	LGN	CUO	VTR	NFG	GRES
MEL	GOF	LGN	CUO	VTR	NFG	GRES

L P H

P20111212V 120 120 73,4

P2011



Tavolo riunione quadrato P. 120

Square meeting table D. 120
Table de réunion carré P. 120
Mesa de juntas cuadrada P. 120

Struttura alluminio anodizzato

Structure anodised aluminium - Structures aluminium anodisé - Estructura aluminio anodizado

MEL	GOF	LGN	CUO	VTR	NFG	GRES
Melaminico	Goffrato	Legno	Cuoio	Vetro	Vetro antimpronta	Gres
Melamine Mélaminé Melaminico	Embossed Gaufré Lacado	Wood Bois Madera	Leather Cuir Cuero	Glass Verre Vidrio	Antifinger glass Verre antitaches Vidrio anti-huella	Porcelain tiles Grès cérame Gres porcelánico

L P H

P20111212J 120 120 73,4

Struttura rivestita in cuoio

Structure upholstered in leather - Structure revêtue en cuir - Estructura revestida en cuero

MEL	GOF	LGN	CUO	VTR	NFG	GRES
MEL	GOF	LGN	CUO	VTR	NFG	GRES

L P H

P20111212J 120 120 73,4

P2011



Tavolo riunione quadrato P. 150

Square meeting table D. 150
Table de réunion carré P. 150
Mesa de juntas cuadrada P. 150

Struttura alluminio anodizzato

Structure anodised aluminium - Structures aluminium anodisé - Estructura aluminio anodizado

MEL	GOF	LGN	CUO	VTR	NFG	GRES
Melaminico	Goffrato	Legno	Cuoio	Vetro	Vetro antimpronta	Gres
Melamine Mélaminé Melaminico	Embossed Gaufré Lacado	Wood Bois Madera	Leather Cuir Cuero	Glass Verre Vidrio	Antifinger glass Verre antitaches Vidrio anti-huella	Porcelain tiles Grès cérame Gres porcelánico

L P H

P20111515 150 150 73,4

Struttura rivestita in cuoio

Structure upholstered in leather - Structure revêtue en cuir - Estructura revestida en cuero

MEL	GOF	LGN	CUO	VTR	NFG	GRES
MEL	GOF	LGN	CUO	VTR	NFG	GRES

L P H

P20111515 150 150 73,4

P2011

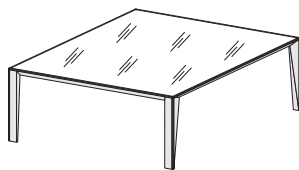

Tavolo riunione quadrato P. 150

Square meeting table D. 150
Table de réunion carré P. 150
Mesa de juntas cuadrada P. 150

Struttura alluminio anodizzato

Structure anodised aluminium - Structures aluminium anodisé - Estructura aluminio anodizado

MEL	GOF	LGN	CUO	VTR	NFG	GRES
Melaminico	Goffrato	Legno	Cuoio	Vetro	Vetro antimpronta	Gres
Melamine Mélaminé Melaminico	Embossed Gaufré Lacado	Wood Bois Madera	Leather Cuir Cuero	Glass Verre Vidrio	Antifinger glass Verre antitaches Vidrio anti-huella	Porcelain tiles Grès cérame Gres porcelánico

	L	P	H							
P20111515V	150	150	73,4	-	-	-	-	3.548	3.902	-

Struttura rivestita in cuoio

Structure upholstered in leather - Structure revêtue en cuir - Estructura revestida en cuero

MEL	GOF	LGN	CUO	VTR	NFG	GRES
MEL	GOF	LGN	CUO	VTR	NFG	GRES

	L	P	H							
P20111515V	150	150	73,4	-	-	-	-	4835	5189	-

P2011



Tavolo riunione quadrato P. 150

Square meeting table D. 150
Table de réunion carré P. 150
Mesa de juntas cuadrada P. 150

Struttura alluminio anodizzato

Structure anodised aluminium - Structures aluminium anodisé - Estructura aluminio anodizado

MEL	GOF	LGN	CUO	VTR	NFG	GRES
Melaminico	Goffrato	Legno	Cuoio	Vetro	Vetro antimpronta	Gres
Melamine Mélaminé Melaminico	Embossed Gaufré Lacado	Wood Bois Madera	Leather Cuir Cuero	Glass Verre Vidrio	Antifinger glass Verre antitaches Vidrio anti-huella	Porcelain tiles Grès cérame Gres porcelánico

	L	P	H							
P20111515J	150	150	73,4	-	-	-	-	-	-	4.125

Struttura rivestita in cuoio

Structure upholstered in leather - Structure revêtue en cuir - Estructura revestida en cuero

MEL	GOF	LGN	CUO	VTR	NFG	GRES
MEL	GOF	LGN	CUO	VTR	NFG	GRES

	L	P	H							
P20111515J	150	150	73,4	-	-	-	-	-	-	5412

P2011

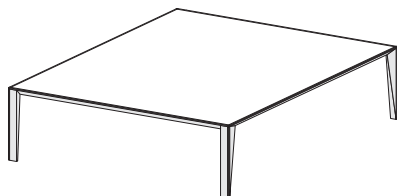

Tavolo riunione quadrato P. 200

Square meeting table D. 200
Table de réunion carré P. 200
Mesa de juntas cuadrada P. 200

Struttura alluminio anodizzato

Structure anodised aluminium - Structures aluminium anodisé - Estructura aluminio anodizado

MEL	GOF	LGN	CUO	VTR	NFG	GRES
Melaminico	Goffrato	Legno	Cuoio	Vetro	Vetro antimpronta	Gres
Melamine Mélaminé Melaminico	Embossed Gaufré Lacado	Wood Bois Madera	Leather Cuir Cuero	Glass Verre Vidrio	Antifinger glass Verre antitaches Vidrio anti-huella	Porcelain tiles Grès cérame Gres porcelánico

	L	P	H							
P20112020	200	200	73,4	2.817	-	4.432	5.511	-	-	-

Struttura rivestita in cuoio

Structure upholstered in leather - Structure revêtue en cuir - Estructura revestida en cuero

MEL	GOF	LGN	CUO	VTR	NFG	GRES
MEL	GOF	LGN	CUO	VTR	NFG	GRES

	L	P	H							
P20112020	200	200	73,4	-	-	5850	6929	-	-	-

Tavoli riunione H. 73,4

Meeting tables H. 73,4 | Tables de réunion H. 73,4 | Mesas de juntas H. 73,4

P2011

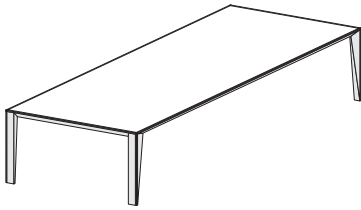

Tavolo riunione rettangolare P. 120

Rectangular meeting table D. 120
Table de réunion rectangulaire P. 120
Mesa de juntas rectangular P. 120

Struttura alluminio anodizzato

Structure anodised aluminium - Structures aluminium anodisé - Estructura aluminio anodizado

MEL	GOF	LGN	CUO	VTR	NFG	GRES
Melaminico	Goffrato	Legno	Cuoio	Vetro	Vetro antimpronta	Gres
Melamine Mélaminé Melaminico	Embossed Gaufré Lacado	Wood Bois Madera	Leather Cuir Cuero	Glass Verre Vidrio	Antifinger glass Verre antitaches Vidrio anti-huella	Porcelain tiles Grès cérame Gres porcelánico

L P H

P20111230	300	120	73,4	2.890	-	3.611	4.628	-	-	-
-----------	-----	-----	------	-------	---	-------	-------	---	---	---

Struttura rivestita in cuoio

Structure upholstered in leather - Structure revêtue en cuir - Estructura revestida en cuero

MEL	GOF	LGN	CUO	VTR	NFG	GRES
-----	-----	-----	-----	-----	-----	------

L P H

P20111230	300	120	73,4	-	-	5039	6056	-	-	-
-----------	-----	-----	------	---	---	------	------	---	---	---

P2011

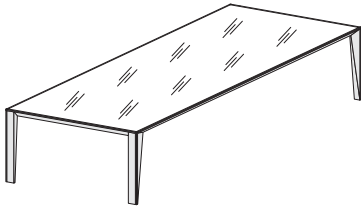

Tavolo riunione rettangolare P. 120

Rectangular meeting table D. 120
Table de réunion rectangulaire P. 120
Mesa de juntas rectangular P. 120

Struttura alluminio anodizzato

Structure anodised aluminium - Structures aluminium anodisé - Estructura aluminio anodizado

MEL	GOF	LGN	CUO	VTR	NFG	GRES
Melaminico	Goffrato	Legno	Cuoio	Vetro	Vetro antimpronta	Gres
Melamine Mélaminé Melaminico	Embossed Gaufré Lacado	Wood Bois Madera	Leather Cuir Cuero	Glass Verre Vidrio	Antifinger glass Verre antitaches Vidrio anti-huella	Porcelain tiles Grès cérame Gres porcelánico

L P H

P20111230V	300	120	73,4	-	-	-	-	4.599	5.196	-
------------	-----	-----	------	---	---	---	---	-------	-------	---

Struttura rivestita in cuoio

Structure upholstered in leather - Structure revêtue en cuir - Estructura revestida en cuero

MEL	GOF	LGN	CUO	VTR	NFG	GRES
-----	-----	-----	-----	-----	-----	------

L P H

P20111230V	300	120	73,4	-	-	-	-	6027	6624	-
------------	-----	-----	------	---	---	---	---	------	------	---

P2011



Tavolo riunione rettangolare P. 120

Rectangular meeting table D. 120
Table de réunion rectangulaire P. 120
Mesa de juntas rectangular P. 120

Struttura alluminio anodizzato

Structure anodised aluminium - Structures aluminium anodisé - Estructura aluminio anodizado

MEL	GOF	LGN	CUO	VTR	NFG	GRES
Melaminico	Goffrato	Legno	Cuoio	Vetro	Vetro antimpronta	Gres
Melamine Mélaminé Melaminico	Embossed Gaufré Lacado	Wood Bois Madera	Leather Cuir Cuero	Glass Verre Vidrio	Antifinger glass Verre antitaches Vidrio anti-huella	Porcelain tiles Grès cérame Gres porcelánico

L P H

P20111230J	300	120	73,4	-	-	-	-	-	-	5.552
------------	-----	-----	------	---	---	---	---	---	---	-------

Struttura rivestita in cuoio

Structure upholstered in leather - Structure revêtue en cuir - Estructura revestida en cuero

MEL	GOF	LGN	CUO	VTR	NFG	GRES
-----	-----	-----	-----	-----	-----	------

L P H

P20111230J	300	120	73,4	-	-	-	-	-	-	6980
------------	-----	-----	------	---	---	---	---	---	---	------

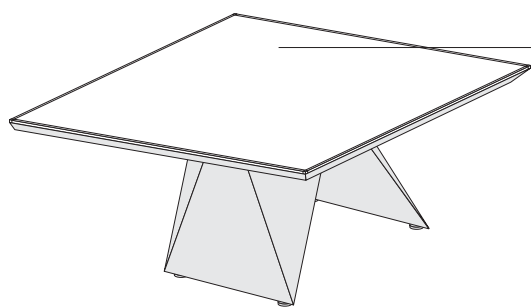

TPPN **Tipo piano**
Desk type
Modele plateau
Tipo sobre

COPL **Colore piano**
Top finishing
Finition plateau
Acabado sobre

Configurazione piani in legno

Wooden tops configuration - Configuration plateaux en ébénisterie - Configuración sobres de madera

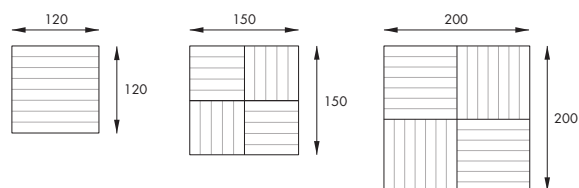

Disposizione cuciture su piani in cuoio

Sewing layout on leather desk-top - Schéma de coutures sur plateaux en cuir - Disposición de las costuras en sobre de mesa en cuero

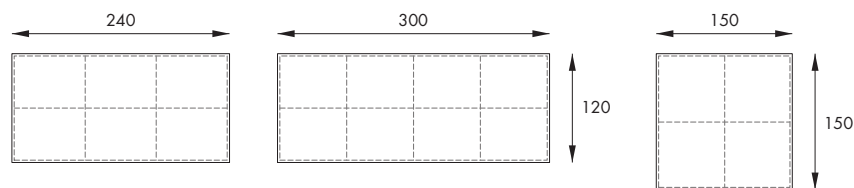

P20123

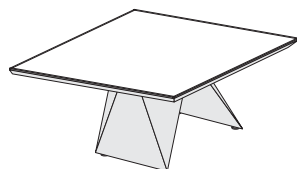

Tavolo riunione quadrato P. 150, con doppio basamento

Square meeting table D. 150, with double base
Table de réunion carré P. 150, avec base double
Mesa de juntas cuadrada P. 150, con base doble

Struttura alluminio anodizzato

Structure anodised aluminium - Structures aluminium anodisé - Estructura aluminio anodizado

MEL	GOF	LGN	CUO	VTR	NFG	GRES
Melaminico	Goffrato	Legno	Cuoio	Vetro	Vetro antimpronta	Gres
Melamine	Embossed	Wood	Leather	Glass	Antifinger glass	Porcelain tiles
Méla miné	Gaufré	Bois	Cuir	Verre	Verre antitaches	Grès cérame
Melaminico	Lacado	Madera	Cuero	Vidrio	Vidrio anti-huella	Gres porcelánico

L P H

P201215152	150	150	73,4	3.837	-	4.762	4.990	-	-	-
-------------------	-----	-----	------	-------	---	-------	-------	---	---	---

P20123

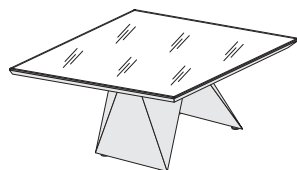

Tavolo riunione quadrato P. 150, con doppio basamento

Square meeting table D. 150, with double base
Table de réunion carré P. 150, avec base double
Mesa de juntas cuadrada P. 150, con base doble

Struttura alluminio anodizzato

Structure anodised aluminium - Structures aluminium anodisé - Estructura aluminio anodizado

MEL	GOF	LGN	CUO	VTR	NFG	GRES
Melaminico	Goffrato	Legno	Cuoio	Vetro	Vetro antimpronta	Gres
Melamine	Embossed	Wood	Leather	Glass	Antifinger glass	Porcelain tiles
Méla miné	Gaufré	Bois	Cuir	Verre	Verre antitaches	Grès cérame
Melaminico	Lacado	Madera	Cuero	Vidrio	Vidrio anti-huella	Gres porcelánico

L P H

P201215152V	150	150	73,4	-	-	-	-	4.807	5.161	-
--------------------	-----	-----	------	---	---	---	---	-------	-------	---

P20123

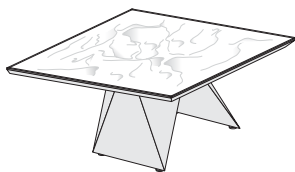

Tavolo riunione quadrato P. 150, con doppio basamento

Square meeting table D. 150, with double base
Table de réunion carré P. 150, avec base double
Mesa de juntas cuadrada P. 150, con base doble

Struttura alluminio anodizzato

Structure anodised aluminium - Structures aluminium anodisé - Estructura aluminio anodizado

MEL	GOF	LGN	CUO	VTR	NFG	GRES
Melaminico	Goffrato	Legno	Cuoio	Vetro	Vetro antimpronta	Gres
Melamine	Embossed	Wood	Leather	Glass	Antifinger glass	Porcelain tiles
Méla miné	Gaufré	Bois	Cuir	Verre	Verre antitaches	Grès cérame
Melaminico	Lacado	Madera	Cuero	Vidrio	Vidrio anti-huella	Gres porcelánico

L P H

P201215152J	150	150	73,4	-	-	-	-	-	5.384
--------------------	-----	-----	------	---	---	---	---	---	-------

P20122

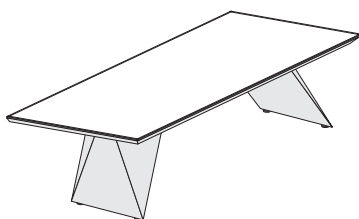

Tavolo riunione rettangolare P. 120, con doppio basamento

Rectangular meeting table D. 120, with double base
Table de réunion rectangulaire P. 120, avec base double
Mesa de juntas rectangular P. 120, con base doble

Struttura alluminio anodizzato

Structure anodised aluminium - Structures aluminium anodisé - Estructura aluminio anodizado

MEL	GOF	LGN	CUO	VTR	NFG	GRES
Melaminico	Goffrato	Legno	Cuoio	Vetro	Vetro antimpronta	Gres
Melamine	Embossed	Wood	Leather	Glass	Antifinger glass	Porcelain tiles
Méla miné	Gaufré	Bois	Cuir	Verre	Verre antitaches	Grès cérame
Melaminico	Lacado	Madera	Cuero	Vidrio	Vidrio anti-huella	Gres porcelánico

L P H

P201212242	240	120	73,4	3.870	-	4.466	5.186	-	-
P201212302	300	120	73,4	4.150	-	4.871	5.888	-	-

P20122

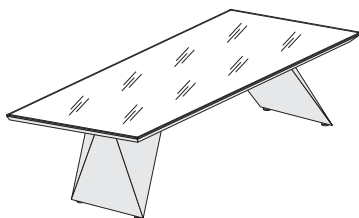

Tavolo riunione rettangolare P. 120, con doppio basamento

Rectangular meeting table D. 120, with double base
Table de réunion rectangulaire P. 120, avec base double
Mesa de juntas rectangular P. 120, con base doble

Struttura alluminio anodizzato

Structure anodised aluminium - Structures aluminium anodisé - Estructura aluminio anodizado

MEL	GOF	LGN	CUO	VTR	NFG	GRES
Melaminico	Goffrato	Legno	Cuoio	Vetro	Vetro antimpronta	Gres
Melamine	Embossed	Wood	Leather	Glass	Antifinger glass	Porcelain tiles
Méla miné	Gaufré	Bois	Cuir	Verre	Verre antitaches	Grès cérame
Melaminico	Lacado	Madera	Cuero	Vidrio	Vidrio anti-huella	Gres porcelánico

L P H

P201212242V	240	120	73,4	-	-	-	-	4.983	5.394	-
P201212302V	300	120	73,4	-	-	-	-	5.859	6.456	-

P20122

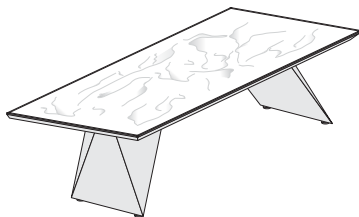

Tavolo riunione rettangolare P. 120, con doppio basamento

Rectangular meeting table D. 120, with double base
Table de réunion rectangulaire P. 120, avec base double
Mesa de juntas rectangular P. 120, con base doble

Struttura alluminio anodizzato

Structure anodised aluminium - Structures aluminium anodisé - Estructura aluminio anodizado

MEL	GOF	LGN	CUO	VTR	NFG	GRES
Melaminico	Goffrato	Legno	Cuoio	Vetro	Vetro antimpronta	Gres
Melamine	Embossed	Wood	Leather	Glass	Antifinger glass	Porcelain tiles
Méla miné	Gaufré	Bois	Cuir	Verre	Verre antitaches	Grès cérame
Melaminico	Lacado	Madera	Cuero	Vidrio	Vidrio anti-huella	Gres porcelánico

L P H

P201212242J	240	120	73,4	-	-	-	-	-	5.769
P201212302J	300	120	73,4	-	-	-	-	-	6.812

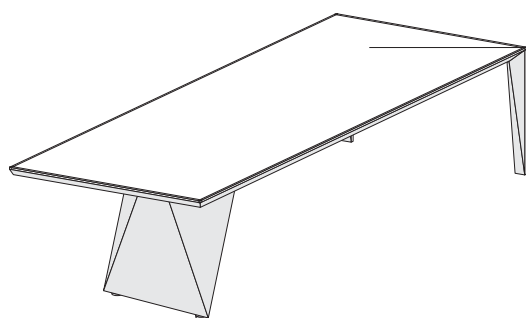

TPPN **Tipo piano**
Desk type
Modele plateau
Tipo sobre

COPL **Colore piano**
Top finishing
Finition plateau
Acabado sobre

Disposizione cuciture su piani in cuoio

Sewing layout on leather desk-top - Schéma de coutures sur plateaux en cuir - Disposición de las costuras en sobre de mesa en cuero

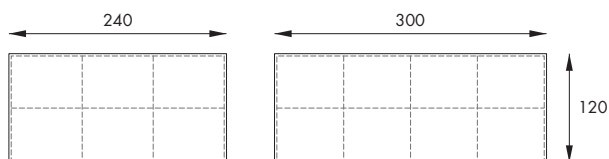

P20121

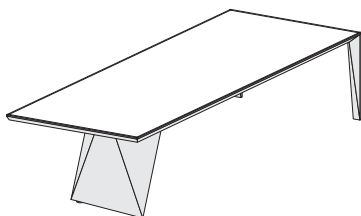

Tavolo riunione rettangolare P. 120, con 1 basamento e 2 gambe

Rectangular meeting table D. 120, with single base and 2 legs
Table de réunion rectangulaire P. 120, avec base simple et 2 pieds
Mesa de juntas rectangular P. 120, con base unica y 2 patas

Struttura alluminio anodizzato

Structure anodised aluminium - Structures aluminium anodisé - Estructura aluminio anodizado

MEL	GOF	LGN	CUO	VTR	NFG	GRES
Melaminico	Goffrato	Legno	Cuoio	Vetro	Vetro antimpronta	Gres
Melamine	Embossed	Wood	Leather	Glass	Antifinger glass	Porcelain tiles
Mélininé	Gaufré	Bois	Cuir	Verre	Verre antitaches	Grès cérame
Melaminico	Lacado	Madera	Cuero	Vidrio	Vidrio anti-huella	Gres porcelánico

L P H

P201212241	240	120	73,4	3.240	-	3.836	4.556	-	-	-
P201212301	300	120	73,4	3.520	-	4.241	5.258	-	-	-

P20121

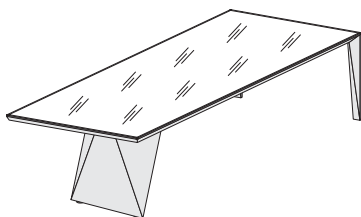

Tavolo riunione rettangolare P. 120, con 1 basamento e 2 gambe

Rectangular meeting table D. 120, with single base and 2 legs
Table de réunion rectangulaire P. 120, avec base simple et 2 pieds
Mesa de juntas rectangular P. 120, con base unica y 2 patas

Struttura alluminio anodizzato

Structure anodised aluminium - Structures aluminium anodisé - Estructura aluminio anodizado

MEL	GOF	LGN	CUO	VTR	NFG	GRES
Melaminico	Goffrato	Legno	Cuoio	Vetro	Vetro antimpronta	Gres
Melamine	Embossed	Wood	Leather	Glass	Antifinger glass	Porcelain tiles
Mélininé	Gaufré	Bois	Cuir	Verre	Verre antitaches	Grès cérame
Melaminico	Lacado	Madera	Cuero	Vidrio	Vidrio anti-huella	Gres porcelánico

L P H

P201212241V	240	120	73,4	-	-	-	-	4.353	4.764	-
P201212301V	300	120	73,4	-	-	-	-	5.229	5.826	-

P20121

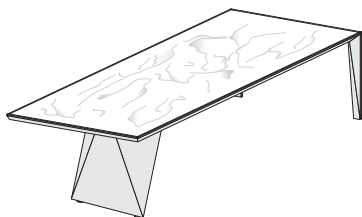

Tavolo riunione rettangolare P. 120, con 1 basamento e 2 gambe

Rectangular meeting table D. 120, with single base and 2 legs
 Table de réunion rectangulaire P. 120, avec base simple et 2 pieds
 Mesa de juntas rectangular P. 120, con base unica y 2 patas

Struttura alluminio anodizzato

Structure anodised aluminium - Structures aluminium anodisé - Estructura aluminio anodizado

MEL	GOF	LGN	CUO	VTR	NFG	GRES
Melaminico	Goffrato	Legno	Cuoio	Vetro	Vetro antimpronta	Gres
Melamine	Embossed	Wood	Leather	Glass	Antifinger glass	Porcelain tiles
Méla miné	Gaufré	Bois	Cuir	Verre	Verre antitaches	Grès cérame
Melaminico	Lacado	Madera	Cuero	Vidrio	Vidrio anti-huella	Gres porcelánico

	L	P	H							
P201212241J	240	120	73,4	-	-	-	-	-	-	5.139
P201212301J	300	120	73,4	-	-	-	-	-	-	6.182

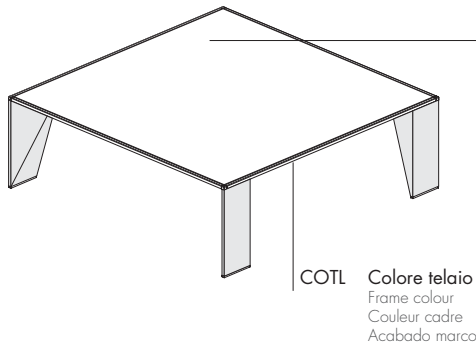

TPPN Tipo piano
Desk type
Modele plateau
Tipo sobre

COPL Colore piano
Top finishing
Finition plateau
Acabado sobre

COTL Colore telaio
Frame colour
Couleur cadre
Acabado marco

Disposizione cuciture su piani in cuoio

Sewing layout on leather desk-top - Schéma de coutures sur plateaux en cuir - Disposición de las costuras en sobre de mesa en cuero

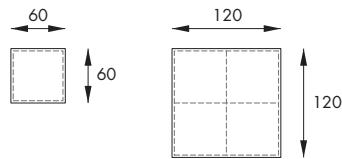

P2013

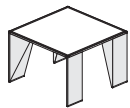

Tavolino quadrato P. 60

Square coffee table D. 60

Table basse carrée P. 60

Mesita cuadrada P. 60

Struttura alluminio anodizzato

Structure anodised aluminium - Structures aluminium anodisé - Estructura aluminio anodizado

MEL	GOF	LGN	CUO	VTR	NFG	GRES
Melaminico	Goffrato	Legno	Cuoio	Vetro	Vetro antimpronta	Gres
Melamine	Embossed	Wood	Leather	Glass	Antifinger glass	Porcelain tiles
Méla miné	Gaufré	Bois	Cuir	Verre	Verre antitaches	Grès cérame
Melaminico	Lacado	Madera	Cuero	Vidrio	Vidrio anti-huella	Gres porcelánico

	L	P	H						
P20130606	60	60	40	1.303	-	1.380	1.469	-	-

Struttura rivestita in cuoio

Structure upholstered in leather - Structure revêtue en cuir - Estructura revestida en cuero

MEL	GOF	LGN	CUO	VTR	NFG	GRES
-----	-----	-----	-----	-----	-----	------

P20130606	60	60	40	-	-	1977	2066	-	-
------------------	----	----	----	---	---	------	------	---	---

P2013

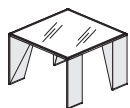

Tavolino quadrato P. 60

Square coffee table D. 60

Table basse carrée P. 60

Mesita cuadrada P. 60

Struttura alluminio anodizzato

Structure anodised aluminium - Structures aluminium anodisé - Estructura aluminio anodizado

MEL	GOF	LGN	CUO	VTR	NFG	GRES
Melaminico	Goffrato	Legno	Cuoio	Vetro	Vetro antimpronta	Gres
Melamine	Embossed	Wood	Leather	Glass	Antifinger glass	Porcelain tiles
Méla miné	Gaufré	Bois	Cuir	Verre	Verre antitaches	Grès cérame
Melaminico	Lacado	Madera	Cuero	Vidrio	Vidrio anti-huella	Gres porcelánico

	L	P	H						
P20130606V	60	60	40	-	-	-	-	1.447	1.502

Struttura rivestita in cuoio

Structure upholstered in leather - Structure revêtue en cuir - Estructura revestida en cuero

MEL	GOF	LGN	CUO	VTR	NFG	GRES
-----	-----	-----	-----	-----	-----	------

P20130606V	60	60	40	-	-	-	-	2044	2099
-------------------	----	----	----	---	---	---	---	------	------

P2013



Tavolino quadrato P. 60

Square coffee table D. 60
Table basse carrée P. 60
Mesita cuadrada P. 60

Struttura alluminio anodizzato

Structure anodised aluminium - Structures aluminium anodisé - Estructura aluminio anodizado

MEL	GOF	LGN	CUO	VTR	NFG	GRES
Melaminico	Goffrato	Legno	Cuoio	Vetro	Vetro antimpronta	Gres
Melamine Mélaminé Melaminico	Embossed Gaufré Lacado	Wood Bois Madera	Leather Cuir Cuero	Glass Verre Vidrio	Antifinger glass Verre antitaches Vidrio anti-huella	Porcelain tiles Grès cérame Gres porcelánico

L P H

P20130606J	60	60	40	-	-	-	-	-	1.926
-------------------	----	----	----	---	---	---	---	---	-------

Struttura rivestita in cuoio

Structure upholstered in leather - Structure revêtue en cuir - Estructura revestida en cuero

MEL	GOF	LGN	CUO	VTR	NFG	GRES
-----	-----	-----	-----	-----	-----	------

L P H

P20130606J	60	60	40	-	-	-	-	-	2523
-------------------	----	----	----	---	---	---	---	---	------

P2013

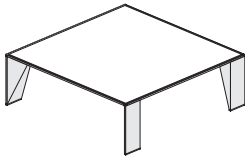

Tavolino quadrato P. 120

Square coffee table D. 120
Table basse carrée P. 120
Mesita cuadrada P. 120

Struttura alluminio anodizzato

Structure anodised aluminium - Structures aluminium anodisé - Estructura aluminio anodizado

MEL	GOF	LGN	CUO	VTR	NFG	GRES
Melaminico	Goffrato	Legno	Cuoio	Vetro	Vetro antimpronta	Gres
Melamine Mélaminé Melaminico	Embossed Gaufré Lacado	Wood Bois Madera	Leather Cuir Cuero	Glass Verre Vidrio	Antifinger glass Verre antitaches Vidrio anti-huella	Porcelain tiles Grès cérame Gres porcelánico

L P H

P20131212	120	120	40	1.738	-	2.009	2.513	-	-
------------------	-----	-----	----	-------	---	-------	-------	---	---

Struttura rivestita in cuoio

Structure upholstered in leather - Structure revêtue en cuir - Estructura revestida en cuero

MEL	GOF	LGN	CUO	VTR	NFG	GRES
-----	-----	-----	-----	-----	-----	------

L P H

P20131212	120	120	40	-	-	2858	3362	-	-
------------------	-----	-----	----	---	---	------	------	---	---

P2013

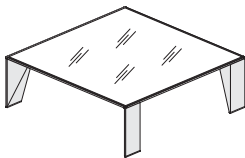

Tavolino quadrato P. 120

Square coffee table D. 120
Table basse carrée P. 120
Mesita cuadrada P. 120

Struttura alluminio anodizzato

Structure anodised aluminium - Structures aluminium anodisé - Estructura aluminio anodizado

MEL	GOF	LGN	CUO	VTR	NFG	GRES
Melaminico	Goffrato	Legno	Cuoio	Vetro	Vetro antimpronta	Gres
Melamine Mélaminé Melaminico	Embossed Gaufré Lacado	Wood Bois Madera	Leather Cuir Cuero	Glass Verre Vidrio	Antifinger glass Verre antitaches Vidrio anti-huella	Porcelain tiles Grès cérame Gres porcelánico

L P H

P20131212V	120	120	40	-	-	-	-	2.369	2.606
-------------------	-----	-----	----	---	---	---	---	-------	-------

Struttura rivestita in cuoio

Structure upholstered in leather - Structure revêtue en cuir - Estructura revestida en cuero

MEL	GOF	LGN	CUO	VTR	NFG	GRES
-----	-----	-----	-----	-----	-----	------

L P H

P20131212V	120	120	40	-	-	-	-	3218	3455
-------------------	-----	-----	----	---	---	---	---	------	------

P2013

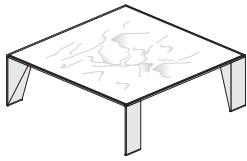

Tavolino quadrato P. 120

Square coffee table D. 120

Table basse carrée P. 120

Mesita cuadrada P. 120

Struttura alluminio anodizzato

Structure anodised aluminium - Structures aluminium anodisé - Estructura aluminio anodizado

MEL	GOF	LGN	CUO	VTR	NFG	GRES
Melaminico	Goffrato	Legno	Cuoio	Vetro	Vetro antimpronta	Gres
Melamine	Embossed	Wood	Leather	Glass	Antifinger glass	Porcelain tiles
Mélatiné	Gaufré	Bois	Cuir	Verre	Verre antitaches	Grès cérame
Melaminico	Lacado	Madera	Cuero	Vidrio	Vidrio anti-huella	Gres porcelánico

	L	P	H							
P20131212J	120	120	40	-	-	-	-	-	-	2.867

Struttura rivestita in cuoio

Structure upholstered in leather - Structure revêtue en cuir - Estructura revestida en cuero

MEL	GOF	LGN	CUO	VTR	NFG	GRES
-----	-----	-----	-----	-----	-----	------

	L	P	H							
P20131212J	120	120	40	-	-	-	-	-	-	3716

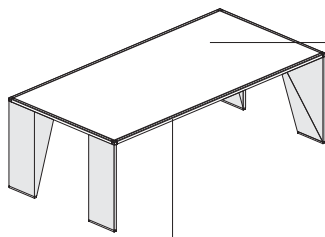

COTL Colore telaio
Frame colour
Couleur cadre
Acabado marco

TPPN Tipo piano
Desk type
Modèle plateau
Tipo sobre

COPL Colore piano
Top finishing
Finition plateau
Acabado sobre

Disposizione cuciture su piani in cuoio

Sewing layout on leather desk-top - Schéma de coutures sur plateaux en cuir - Disposición de las costuras en sobre de mesa en cuero

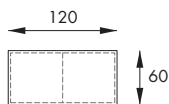

P2013

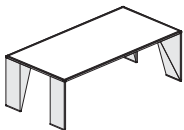

Tavolino rettangolare P. 60

Rectangular coffee table D. 60
Table basse rectangulaire P. 60
Mesita rectangular P. 60

Struttura alluminio anodizzato

Structure anodised aluminium - Structures aluminium anodisé - Estructura aluminio anodizado

MEL	GOF	LGN	CUO	VTR	NFG	GRES
Melaminico	Goffrato	Legno	Cuoio	Vetro	Vetro antimpronta	Gres
Melamine	Embossed	Wood	Leather	Glass	Antifinger glass	Porcelain tiles
Mélatiné	Gaufré	Bois	Cuir	Verre	Verre antitaches	Grès cérame
Melaminico	Lacado	Madera	Cuero	Vidrio	Vidrio anti-huella	Gres porcelánico

L P H

P20130612 120 60 40

Struttura rivestita in cuoio

Structure upholstered in leather - Structure revêtue en cuir - Estructura revestida en cuero

MEL	GOF	LGN	CUO	VTR	NFG	GRES
MEL	GOF	LGN	CUO	VTR	NFG	GRES

L P H

P20130612 120 60 40

P2013

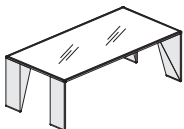

Tavolino rettangolare P. 60

Rectangular coffee table D. 60
Table basse rectangulaire P. 60
Mesita rectangular P. 60

Struttura alluminio anodizzato

Structure anodised aluminium - Structures aluminium anodisé - Estructura aluminio anodizado

MEL	GOF	LGN	CUO	VTR	NFG	GRES
Melaminico	Goffrato	Legno	Cuoio	Vetro	Vetro antimpronta	Gres
Melamine	Embossed	Wood	Leather	Glass	Antifinger glass	Porcelain tiles
Mélatiné	Gaufré	Bois	Cuir	Verre	Verre antitaches	Grès cérame
Melaminico	Lacado	Madera	Cuero	Vidrio	Vidrio anti-huella	Gres porcelánico

L P H

P20130612V 120 60 40

Struttura rivestita in cuoio

Structure upholstered in leather - Structure revêtue en cuir - Estructura revestida en cuero

MEL	GOF	LGN	CUO	VTR	NFG	GRES
MEL	GOF	LGN	CUO	VTR	NFG	GRES

L P H

P20130612V 120 60 40

P2013



Tavolino rettangolare P. 60

Rectangular coffee table D. 60
Table basse rectangulaire P. 60
Mesita rectangular P. 60

Struttura alluminio anodizzato

Structure anodised aluminium - Structures aluminium anodisé - Estructura aluminio anodizado

MEL	GOF	LGN	CUO	VTR	NFG	GRES
Melaminico	Goffrato	Legno	Cuoio	Vetro	Vetro antimpronta	Gres
Melamine	Embossed	Wood	Leather	Glass	Antifinger glass	Porcelain tiles
Mélatiné	Gaufré	Bois	Cuir	Verre	Verre antitaches	Grès cérame
Melaminico	Lacado	Madera	Cuero	Vidrio	Vidrio anti-huella	Gres porcelánico

	L	P	H							
P20130612J	120	60	40	-	-	-	-	-	-	2.359

Struttura rivestita in cuoio

Structure upholstered in leather - Structure revêtue en cuir - Estructura revestida en cuero

MEL	GOF	LGN	CUO	VTR	NFG	GRES
-----	-----	-----	-----	-----	-----	------

	L	P	H							
P20130612J	120	60	40	-	-	-	-	-	-	3251

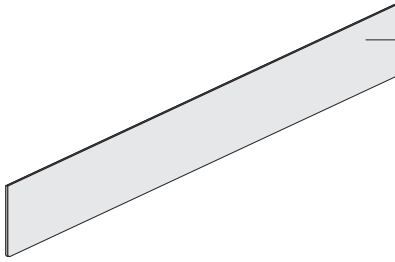

COMD Colore modesty panel
 Modesty panel finishing
 Finition voile de fond
 Acabado faldón

P2026

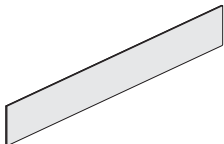

Modesty panel (completo di supporti)

Modesty panel (brackets included)
 Voile de fond (support inclus)
 Faldón (soportes incluidos)

				MEL	GOF	LGN	CUO
				Melaminico	Goffrato	Legno	Cuoio
				Melamine	Embossed	Wood	Leather
				Méla miné	Gaufré	Bois	Cuir
				Melaminico	Lacado	Madera	Cuero
	L	P	H				
P202620003	200	1,8	33	158	203	329	494
P202624003	240	1,8	33	190	245	392	593

Desk tops | Plateaux bureaux | Sobres mesa

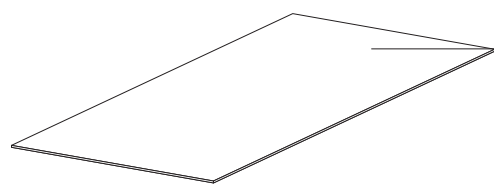

TPPN Tipo piano
Desk type
Modele plateau
Tipo sobre

COPL Colore piano
Top finishing
Finition plateau
Acabado sobre

Disposizione cuciture su piani in cuoio

Sewing layout on leather desk-top - Schéma de coutures sur plateaux en cuir - Disposición de las costuras en sobre de mesa en cuero

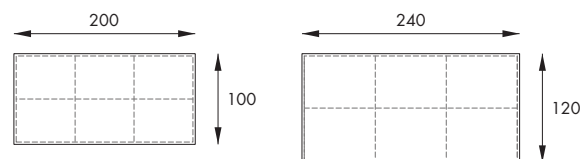

P2017

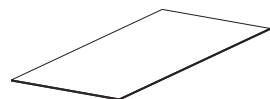

Piano scrivania P. 100

Desk top D. 100
Plateau bureau P. 100
Sobre mesa P. 100

MEL	GOF	LGN	CUO	VTR	NFG	GRES
Melaminico	Goffrato	Legno	Cuoio	Vetro	Vetro antimpronta	Gres
Melamine	Embossed	Wood	Leather	Glass	Antifinger glass	Porcelain tiles
Mélininé	Gaufré	Bois	Cuir	Verre	Verre antitaches	Grès cérame
Melaminico	Lacado	Madera	Cuero	Vidrio	Vidrio anti-huella	Gres porcelánico

	L	P	H						
P20171020	200	100	1,8	188	-	609	1.122	-	-

P2017

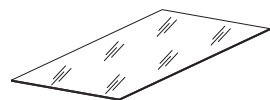

Piano scrivania P. 100

Desk top D. 100
Plateau bureau P. 100
Sobre mesa P. 100

MEL	GOF	LGN	CUO	VTR	NFG	GRES
Melaminico	Goffrato	Legno	Cuoio	Vetro	Vetro antimpronta	Gres
Melamine	Embossed	Wood	Leather	Glass	Antifinger glass	Porcelain tiles
Mélininé	Gaufré	Bois	Cuir	Verre	Verre antitaches	Grès cérame
Melaminico	Lacado	Madera	Cuero	Vidrio	Vidrio anti-huella	Gres porcelánico

	L	P	H						
P20171020V	200	100	0,8	-	-	-	970	1.262	-

P2017

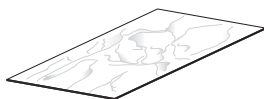

Piano scrivania P. 100

Desk top D. 100
Plateau bureau P. 100
Sobre mesa P. 100

MEL	GOF	LGN	CUO	VTR	NFG	GRES
Melaminico	Goffrato	Legno	Cuoio	Vetro	Vetro antimpronta	Gres
Melamine Mélaminé Melaminico	Embossed Gaufré Lacado	Wood Bois Madera	Leather Cuir Cuero	Glass Verre Vidrio	Antifinger glass Verre antitaches Vidrio anti-huella	Porcelain tiles Grès cérame Gres porcelánico

L P H

P20171020J	200	100	0,6	-	-	-	-	-	1.612
-------------------	-----	-----	-----	---	---	---	---	---	-------

P2017

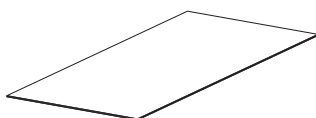

Piano scrivania P. 120

Desk top D. 120
Plateau bureau P. 120
Sobre mesa P. 120

MEL	GOF	LGN	CUO	VTR	NFG	GRES
Melaminico	Goffrato	Legno	Cuoio	Vetro	Vetro antimpronta	Gres
Melamine Mélaminé Melaminico	Embossed Gaufré Lacado	Wood Bois Madera	Leather Cuir Cuero	Glass Verre Vidrio	Antifinger glass Verre antitaches Vidrio anti-huella	Porcelain tiles Grès cérame Gres porcelánico

L P H

P20171224	240	120	1,8	255	-	851	1.571	-	-
------------------	-----	-----	-----	-----	---	-----	-------	---	---

P2017

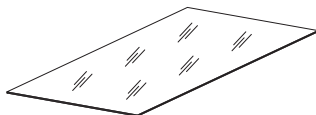

Piano scrivania P. 120

Desk top D. 120
Plateau bureau P. 120
Sobre mesa P. 120

MEL	GOF	LGN	CUO	VTR	NFG	GRES
Melaminico	Goffrato	Legno	Cuoio	Vetro	Vetro antimpronta	Gres
Melamine Mélaminé Melaminico	Embossed Gaufré Lacado	Wood Bois Madera	Leather Cuir Cuero	Glass Verre Vidrio	Antifinger glass Verre antitaches Vidrio anti-huella	Porcelain tiles Grès cérame Gres porcelánico

L P H

P20171224V	240	120	0,8	-	-	-	-	1.368	1.779
-------------------	-----	-----	-----	---	---	---	---	-------	-------

P2017

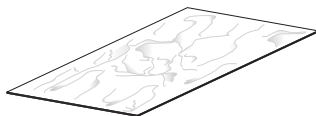

Piano scrivania P. 120

Desk top D. 120
Plateau bureau P. 120
Sobre mesa P. 120

MEL	GOF	LGN	CUO	VTR	NFG	GRES
Melaminico	Goffrato	Legno	Cuoio	Vetro	Vetro antimpronta	Gres
Melamine Mélaminé Melaminico	Embossed Gaufré Lacado	Wood Bois Madera	Leather Cuir Cuero	Glass Verre Vidrio	Antifinger glass Verre antitaches Vidrio anti-huella	Porcelain tiles Grès cérame Gres porcelánico

L P H

P20171224J	240	120	0,6	-	-	-	-	-	2.154
-------------------	-----	-----	-----	---	---	---	---	---	-------

Return tops | Plateaux retour | Sobres ala

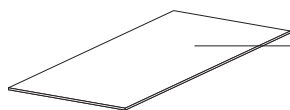

TPPN Tipo piano
Desk type
Modele plateau
Tipo sobre

COPL Colore piano
Top finishing
Finition plateau
Acabado sobre

Disposizione cuciture su piani in cuoio

Sewing layout on leather desk-top - Schéma de coutures sur plateaux en cuir - Disposición de las costuras en sobre de mesa en cuero

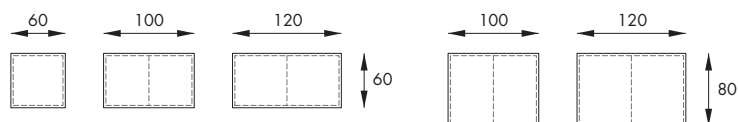

P2017

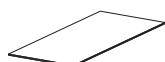

Piano dattilo P. 60

Return top D. 60
Plateau retour P. 60
Sobre ala P. 60

	MEL	GOF	LGN	CUO	VTR	NFG	GRES			
	Melaminico	Goffrato	Legno	Cuoio	Vetro	Vetro antimpronta	Gres			
	Melamine Mélaminé Melaminico	Embossed Gaufré Lacado	Wood Bois Madera	Leather Cuir Cuero	Glass Verre Vidrio	Antifinger glass Verre antitaches Vidrio anti-huella	Porcelain tiles Grès cérame Gres porcelánico			
	L	P	H							
P20170606	60	60	1,8	37	-	114	203	-	-	-
P20170610	100	60	1,8	73	-	229	422	-	-	-
P20170612	120	60	1,8	85	-	278	507	-	-	-

P2017



Piano dattilo P. 60

Return top D. 60
Plateau retour P. 60
Sobre ala P. 60

	MEL	GOF	LGN	CUO	VTR	NFG	GRES			
	Melaminico	Goffrato	Legno	Cuoio	Vetro	Vetro antimpronta	Gres			
	Melamine Mélaminé Melaminico	Embossed Gaufré Lacado	Wood Bois Madera	Leather Cuir Cuero	Glass Verre Vidrio	Antifinger glass Verre antitaches Vidrio anti-huella	Porcelain tiles Grès cérame Gres porcelánico			
	L	P	H							
P20170606V	60	60	0,8	-	-	-	-	181	236	-
P20170610V	100	60	0,8	-	-	-	-	369	479	-
P20170612V	120	60	0,8	-	-	-	-	441	574	-

P2017



Piano dattilo P. 60

Return top D. 60
Plateau retour P. 60
Sobre ala P. 60

	MEL	GOF	LGN	CUO	VTR	NFG	GRES			
	Melaminico	Goffrato	Legno	Cuoio	Vetro	Vetro antimpronta	Gres			
	Melamine Mélaminé Melaminico	Embossed Gaufré Lacado	Wood Bois Madera	Leather Cuir Cuero	Glass Verre Vidrio	Antifinger glass Verre antitaches Vidrio anti-huella	Porcelain tiles Grès cérame Gres porcelánico			
	L	P	H							
P20170606J	60	60	0,6	-	-	-	-	-	-	660
P20170610J	100	60	0,6	-	-	-	-	-	-	799
P20170612J	120	60	0,6	-	-	-	-	-	-	869

P2017



Piano dattilo P. 80

Return top D. 80
Plateau retour P. 80
Sobre ala P. 80

				MEL	GOF	LGN	CUO	VTR	NFG	GRES
				Melaminico	Goffrato	Legno	Cuoio	Vetro	Vetro antimpronta	Gres
				Melamine Mélaminé Melaminico	Embossed Gaufré Lacado	Wood Bois Madera	Leather Cuir Cuero	Glass Verre Vidrio	Antifinger glass Verre antitaches Vidrio anti-huella	Porcelain tiles Grès cérame Gres porcelánico
	L	P	H							
P20170810	100	80	1,8	97	-	308	567	-	-	-
P20170812	120	80	1,8	114	-	359	675	-	-	-

P2017



Piano dattilo P. 80

Return top D. 80
Plateau retour P. 80
Sobre ala P. 80

				MEL	GOF	LGN	CUO	VTR	NFG	GRES
				Melaminico	Goffrato	Legno	Cuoio	Vetro	Vetro antimpronta	Gres
				Melamine Mélaminé Melaminico	Embossed Gaufré Lacado	Wood Bois Madera	Leather Cuir Cuero	Glass Verre Vidrio	Antifinger glass Verre antitaches Vidrio anti-huella	Porcelain tiles Grès cérame Gres porcelánico
	L	P	H							
P20170810V	100	80	0,8	-	-	-	-	489	636	-
P20170812V	120	80	0,8	-	-	-	-	584	760	-

P2017

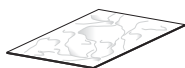

Piano dattilo P. 80

Return top D. 80
Plateau retour P. 80
Sobre ala P. 80

				MEL	GOF	LGN	CUO	VTR	NFG	GRES
				Melaminico	Goffrato	Legno	Cuoio	Vetro	Vetro antimpronta	Gres
				Melamine Mélaminé Melaminico	Embossed Gaufré Lacado	Wood Bois Madera	Leather Cuir Cuero	Glass Verre Vidrio	Antifinger glass Verre antitaches Vidrio anti-huella	Porcelain tiles Grès cérame Gres porcelánico
	L	P	H							
P20170810J	100	80	0,6	-	-	-	-	-	-	916
P20170812J	120	80	0,6	-	-	-	-	-	-	1.008

Top for meeting tables | Plateaux tables de réunion | Sobres para mesas de juntas

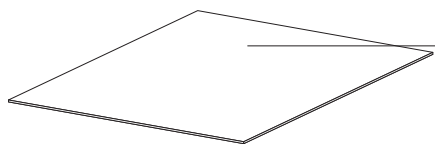

TPPN Tipo piano
Desk type
Modele plateau
Tipo sobre

COPL Colore piano
Top finishing
Finition plateau
Acabado sobre

Configurazione piani in legno

Wooden tops configuration - Configuration plateaux en ébénisterie - Configuración sobres de madera

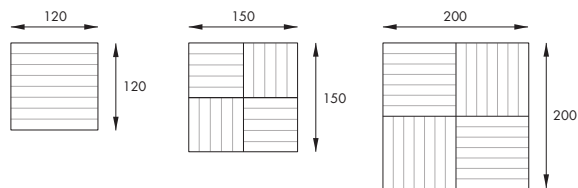

Disposizione cuciture su piani in cuoio

Sewing layout on leather desk-top - Schéma de coutures sur plateaux en cuir - Disposición de las costuras en sobre de mesa en cuero

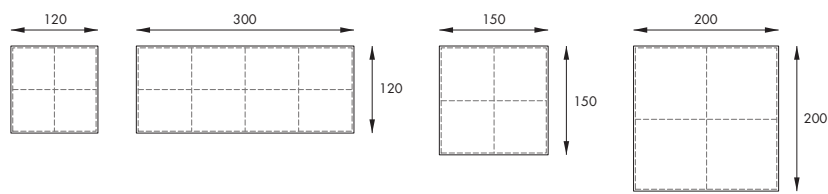

P2017

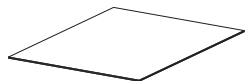

Piano tavolo riunioni quadrato P. 120

Square meeting table top D. 120
Plateau pour table de réunion carré P. 120
Sobre para mesa de juntas cuadrada P. 120

MEL	GOF	LGN	CUO	VTR	NFG	GRES
Melaminico	Goffrato	Legno	Cuoio	Vetro	Vetro antimpronta	Gres
Melamine	Embossed	Wood	Leather	Glass	Antifinger glass	Porcelain tiles
Méla miné	Gaufré	Bois	Cuir	Verre	Verre antitaches	Grès cérame
Melaminico	Lacado	Madera	Cuero	Vidrio	Vidrio anti-huella	Gres porcelánico

L P H
120 120 1,8

P20171212

159

-

430

934

-

-

-

P2017

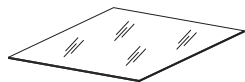

Piano tavolo riunioni quadrato P. 120

Square meeting table top D. 120
Plateau pour table de réunion carré P. 120
Sobre para mesa de juntas cuadrada P. 120

MEL	GOF	LGN	CUO	VTR	NFG	GRES
Melaminico	Goffrato	Legno	Cuoio	Vetro	Vetro antimpronta	Gres
Melamine	Embossed	Wood	Leather	Glass	Antifinger glass	Porcelain tiles
Méla miné	Gaufré	Bois	Cuir	Verre	Verre antitaches	Grès cérame
Melaminico	Lacado	Madera	Cuero	Vidrio	Vidrio anti-huella	Gres porcelánico

L P H
120 120 0,8

P20171212V

-

-

-

-

790

1.027

-

P2017

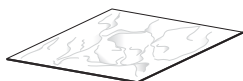

Piano tavolo riunioni quadrato P. 120

Square meeting table top D. 120
Plateau pour table de réunion carré P. 120
Sobre para mesa de juntas cuadrada P. 120

MEL	GOF	LGN	CUO	VTR	NFG	GRES
Melaminico	Goffrato	Legno	Cuoio	Vetro	Vetro antimpronta	Gres
Melamine Mélaminé Melaminico	Embossed Gaufré Lacado	Wood Bois Madera	Leather Cuir Cuero	Glass Verre Vidrio	Antifinger glass Verre antitaches Vidrio anti-huella	Porcelain tiles Grès cérame Gres porcelánico

	L	P	H						
P20171212J	120	120	0,6	-	-	-	-	-	1.288

P2017



Piano tavolo riunioni quadrato P. 150

Square meeting table top D. 150
Plateau pour table de réunion carré P. 150
Sobre para mesa de juntas cuadrada P. 150

MEL	GOF	LGN	CUO	VTR	NFG	GRES
Melaminico	Goffrato	Legno	Cuoio	Vetro	Vetro antimpronta	Gres
Melamine Mélaminé Melaminico	Embossed Gaufré Lacado	Wood Bois Madera	Leather Cuir Cuero	Glass Verre Vidrio	Antifinger glass Verre antitaches Vidrio anti-huella	Porcelain tiles Grès cérame Gres porcelánico

	L	P	H						
P20171515	150	150	1,8	210	-	1.135	1.363	-	-

P2017

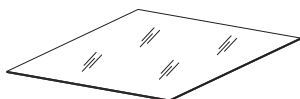

Piano tavolo riunioni quadrato P. 150

Square meeting table top D. 150
Plateau pour table de réunion carré P. 150
Sobre para mesa de juntas cuadrada P. 150

MEL	GOF	LGN	CUO	VTR	NFG	GRES
Melaminico	Goffrato	Legno	Cuoio	Vetro	Vetro antimpronta	Gres
Melamine Mélaminé Melaminico	Embossed Gaufré Lacado	Wood Bois Madera	Leather Cuir Cuero	Glass Verre Vidrio	Antifinger glass Verre antitaches Vidrio anti-huella	Porcelain tiles Grès cérame Gres porcelánico

	L	P	H						
P20171515V	150	150	0,8	-	-	-	-	1.180	1.534

P2017

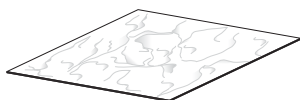

Piano tavolo riunioni quadrato P. 150

Square meeting table top D. 150
Plateau pour table de réunion carré P. 150
Sobre para mesa de juntas cuadrada P. 150

MEL	GOF	LGN	CUO	VTR	NFG	GRES
Melaminico	Goffrato	Legno	Cuoio	Vetro	Vetro antimpronta	Gres
Melamine Mélaminé Melaminico	Embossed Gaufré Lacado	Wood Bois Madera	Leather Cuir Cuero	Glass Verre Vidrio	Antifinger glass Verre antitaches Vidrio anti-huella	Porcelain tiles Grès cérame Gres porcelánico

	L	P	H						
P20171515J	150	150	0,6	-	-	-	-	-	1.757

P2017

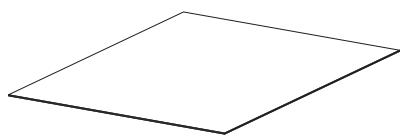

Piano tavolo riunioni quadrato P. 200

Square meeting table top D. 200
Plateau pour table de réunion carré P. 200
Sobre para mesa de juntas cuadrada P. 200

MEL	GOF	LGN	CUO	VTR	NFG	GRES
Melaminico	Goffrato	Legno	Cuoio	Vetro	Vetro antimpronta	Gres
Melamine Mélaminé Melaminico	Embossed Gaufré Lacado	Wood Bois Madera	Leather Cuir Cuero	Glass Verre Vidrio	Antifinger glass Verre antitaches Vidrio anti-huella	Porcelain tiles Grès cérame Gres porcelánico

	L	P	H							
P20172020	200	200	1,8	400	-	2.015	3.094	-	-	-

P2017

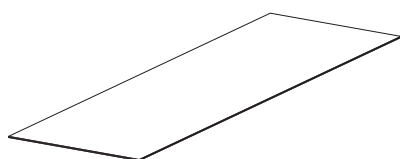

Tavolo riunione rettangolare P. 120

Rectangular meeting table D. 120
Table de réunion rectangulaire P. 120
Mesa de juntas rectangular P. 120

MEL	GOF	LGN	CUO	VTR	NFG	GRES
Melaminico	Goffrato	Legno	Cuoio	Vetro	Vetro antimpronta	Gres
Melamine Mélaminé Melaminico	Embossed Gaufré Lacado	Wood Bois Madera	Leather Cuir Cuero	Glass Verre Vidrio	Antifinger glass Verre antitaches Vidrio anti-huella	Porcelain tiles Grès cérame Gres porcelánico

	L	P	H							
P20171230	300	120	1,8	285	-	1.006	2.023	-	-	-

P2017

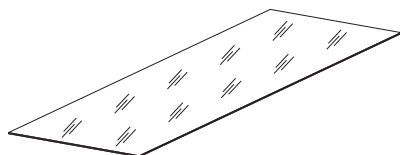

Tavolo riunione rettangolare P. 120

Rectangular meeting table D. 120
Table de réunion rectangulaire P. 120
Mesa de juntas rectangular P. 120

MEL	GOF	LGN	CUO	VTR	NFG	GRES
Melaminico	Goffrato	Legno	Cuoio	Vetro	Vetro antimpronta	Gres
Melamine Mélaminé Melaminico	Embossed Gaufré Lacado	Wood Bois Madera	Leather Cuir Cuero	Glass Verre Vidrio	Antifinger glass Verre antitaches Vidrio anti-huella	Porcelain tiles Grès cérame Gres porcelánico

	L	P	H							
P20171230V	300	120	0,8	-	-	-	2.591	2.591	-	-

P2017

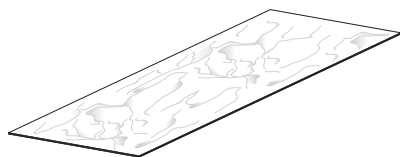

Tavolo riunione rettangolare P. 120

Rectangular meeting table D. 120
Table de réunion rectangulaire P. 120
Mesa de juntas rectangular P. 120

MEL	GOF	LGN	CUO	VTR	NFG	GRES
Melaminico	Goffrato	Legno	Cuoio	Vetro	Vetro antimpronta	Gres
Melamine Mélaminé Melaminico	Embossed Gaufré Lacado	Wood Bois Madera	Leather Cuir Cuero	Glass Verre Vidrio	Antifinger glass Verre antitaches Vidrio anti-huella	Porcelain tiles Grès cérame Gres porcelánico

	L	P	H							
P20171230J	300	120	0,6	-	-	-	-	-	2.947	-

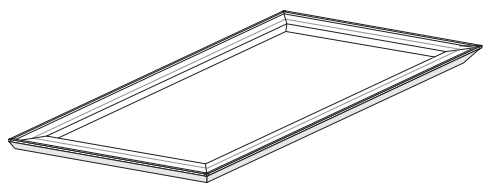

COTL Colore telaio
Frame colour
Couleur cadre
Acabado marco

TPPN Tipo piano
Desk type
Modele plateau
Tipo sobre

P2016

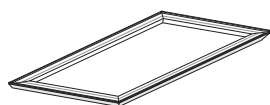

Telaio scrivania P. 100 con 4 gambe

Frame desk D. 100 with 4 legs
Châssis bureau P. 100 avec 4 pieds
Estructura para mesa P. 100 con 4 patas

AL	CUO					
Alluminio	Cuoio					
Aluminium	Leather					
Aluminium	Cuir					
Aluminio	Cuero					

L P H

P20161020 200 100 8 708 1.340

P2016

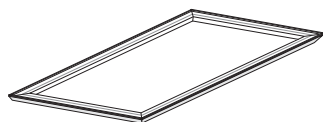

Telaio scrivania P. 120 con 4 gambe

Frame desk D. 120 with 4 legs
Châssis bureau P. 120 avec 4 pieds
Estructura para mesa P. 120 con 4 patas

AL	CUO					
Alluminio	Cuoio					
Aluminium	Leather					
Aluminium	Cuir					
Aluminio	Cuero					

L P H

P20161224 240 120 8 777 1.495

P20172

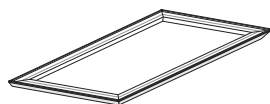

Telaio scrivania P. 100 con 1 basamento e 2 gambe

Frame desk D. 100 with single base and 2 legs
Châssis bureau P. 100 avec base simple et 2 pieds
Estructura para mesa P. 100 con base unica y 2 patas

AL	CUO					
Alluminio	Cuoio					
Aluminium	Leather					
Aluminium	Cuir					
Aluminio	Cuero					

L P H

P201721020 200 100 8 708 1.340

P20172

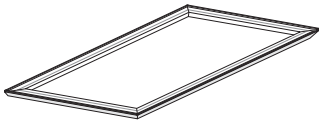

Telaio scrivania P. 120 con 1 basamento e 2 gambe

Frame desk D. 120 with single base and 2 legs
Châssis bureau P. 120 avec base simple et 2 pieds
Estructura para mesa P. 120 con base unica y 2 patas

AL	CUO					
Alluminio	Cuoio					
Aluminium	Leather					
Aluminium	Cuir					
Aluminio	Cuero					
		L	P	H		
P201721224		240	120	8	777	1.495

P20173

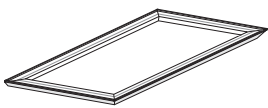

Telaio scrivania P. 100 con doppio basamento

Frame desk D. 100 with double base
Châssis bureau P. 100 avec base double
Estructura para mesa P. 100 con base doble

AL	CUO					
Alluminio	Cuoio					
Aluminium	Leather					
Aluminium	Cuir					
Aluminio	Cuero					
		L	P	H		
P201731020		200	100	8	708	1.340

P20173

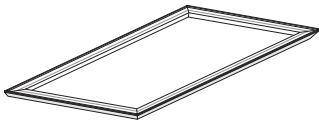

Telaio scrivania P. 120 con doppio basamento

Frame desk D. 120 with double base
Châssis bureau P. 120 avec base double
Estructura para mesa P. 120 con base doble

AL	CUO					
Alluminio	Cuoio					
Aluminium	Leather					
Aluminium	Cuir					
Aluminio	Cuero					
		L	P	H		
P201731224		240	120	8	777	1.495

P2015

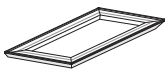

Telaio dattilo P. 60

Frame return D. 60
Châssis retour P. 60
Estructura ala P. 60

AL	CUO					
Alluminio	Cuoio					
Aluminium	Leather					
Aluminium	Cuir					
Aluminio	Cuero					
		L	P	H		
P20150606		60	60	8	312	563
P20150610		100	60	8	430	972
P20150612		120	60	8	536	1.082

P2015

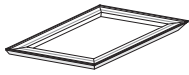

Telaio dattilo P. 80

Frame return D. 80
Châssis retour P. 80
Estructura ala P. 80

	L	P	H	AL	CUO
				Alluminio	Cuoio
				Aluminium	Leather
				Aluminium	Cuir
				Aluminio	Cuero
P20150810	100	80	8	536	1.082
P20150812	120	80	8	590	1.197

P2016

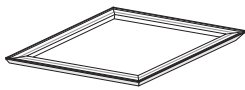

Telaio tavolo riunioni quadrato P. 120 con 4 gambe

Frame square meeting table D. 120 with 4 legs
Châssis table de réunion carré P. 120 avec 4 pieds
Estructura para mesa de juntas cuadrada P. 120 con 4 patas

	L	P	H	AL	CUO
				Alluminio	Cuoio
				Aluminium	Leather
				Aluminium	Cuir
				Aluminio	Cuero
P20161212	120	120	8	625	1.128

P2016

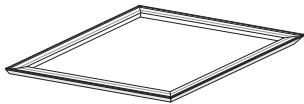

Telaio tavolo riunioni quadrato P. 150 con 4 gambe

Frame square meeting table D. 150 with 4 legs
Châssis table de réunion carré P. 150 avec 4 pieds
Estructura para mesa de juntas cuadrada P. 150 con 4 patas

	L	P	H	AL	CUO
				Alluminio	Cuoio
				Aluminium	Leather
				Aluminium	Cuir
				Aluminio	Cuero
P20161515	150	150	8	790	1.477

P2016

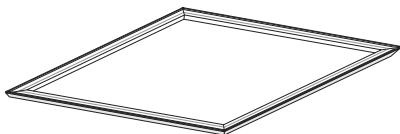

Telaio tavolo riunioni quadrato P. 200 con 4 gambe

Frame square meeting table D. 200 with 4 legs
Châssis table de réunion carré P. 200 avec 4 pieds
Estructura para mesa de juntas cuadrada P. 200 con 4 patas

	L	P	H	AL	CUO
				Alluminio	Cuoio
				Aluminium	Leather
				Aluminium	Cuir
				Aluminio	Cuero
P20162020	200	200	8	839	1.657

P20173

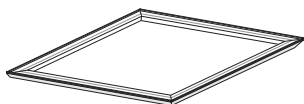

Telaio tavolo riunioni quadrato P. 150 con doppio basamento

Frame square meeting table D. 150 with double base
Châssis table de réunion carré P. 150 avec base double
Estructura para mesa de juntas cuadrada P. 150 con base doble

AL	CUO					
Alluminio	Cuoio					
Aluminium	Leather					
Aluminium	Cuir					
Aluminio	Cuero					

	L	P	H		
P201731515	150	150	8	790	1.477

P2016

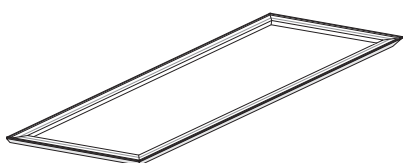

Telaio tavolo riunioni rettangolare P. 120 con 4 gambe

Frame rectangular meeting table D. 120 with 4 legs
Châssis table de réunion rectangulaire P. 120 avec 4 pieds
Estructura para mesa de juntas rectangular P. 120 con 4 patas

AL	CUO					
Alluminio	Cuoio					
Aluminium	Leather					
Aluminium	Cuir					
Aluminio	Cuero					

	L	P	H		
P20161230	300	120	8	1.027	1.855

P20172

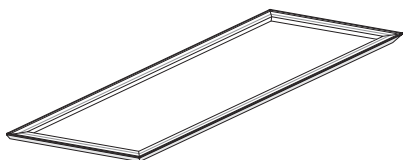

Telaio tavolo riunioni rettangolare P. 120 con 1 basamento e 2 gambe

Frame rectangular meeting table D. 120 with single base and 2 legs
Châssis table de réunion rectangulaire P. 120 avec base simple et 2 pieds
Estructura para mesa de juntas rectangular P. 120 con base unica y 2 patas

AL	CUO					
Alluminio	Cuoio					
Aluminium	Leather					
Aluminium	Cuir					
Aluminio	Cuero					

	L	P	H		
P201721230	300	120	8	1.027	1.855

P20173

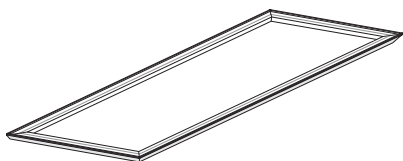

Telaio tavolo riunioni rettangolare P. 120 con doppio basamento

Frame rectangular meeting table D. 120 with double base
Châssis table de réunion rectangulaire P. 120 avec base double
Estructura para mesa de juntas rectangular P. 120 con base doble

AL	CUO					
Alluminio	Cuoio					
Aluminium	Leather					
Aluminium	Cuir					
Aluminio	Cuero					

	L	P	H		
P201731230	300	120	8	1.027	1.855

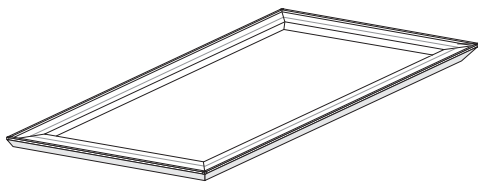

COTL Colore telaio
Frame colour
Couleur cadre
Acabado marco

TPPN Tipo piano
Desk type
Modele plateau
Tipo sobre

P2016

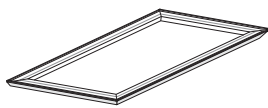

Telaio scrivania P. 100 con 4 gambe

Frame desk D. 100 with 4 legs
Châssis bureau P. 100 avec 4 pieds
Estructura para mesa P. 100 con 4 patas

AL	CUO					
Alluminio	Cuoio					
Aluminium	Leather					
Aluminium	Cuir					
Aluminio	Cuero					

	L	P	H		
P20161020V	200	100	8	708	1.340

P2016

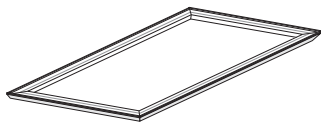

Telaio scrivania P. 120 con 4 gambe

Frame desk D. 120 with 4 legs
Châssis bureau P. 120 avec 4 pieds
Estructura para mesa P. 120 con 4 patas

AL	CUO					
Alluminio	Cuoio					
Aluminium	Leather					
Aluminium	Cuir					
Aluminio	Cuero					

	L	P	H		
P20161224V	240	120	8	777	1.495

P20172

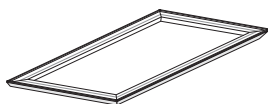

Telaio scrivania P. 100 con 1 basamento e 2 gambe

Frame desk D. 100 with single base and 2 legs
Châssis bureau P. 100 avec base simple et 2 pieds
Estructura para mesa P. 100 con base unica y 2 patas

AL	CUO					
Alluminio	Cuoio					
Aluminium	Leather					
Aluminium	Cuir					
Aluminio	Cuero					

	L	P	H		
P201721020V	200	100	8	708	1.340

P2015

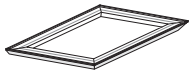

Telaio dattilo P. 80

Frame return D. 80

Châssis retour P. 80

Estructura ala P. 80

	L	P	H	AL	CUO
				Alluminio	Cuoio
				Aluminium	Leather
				Aluminium	Cuir
				Aluminio	Cuero
P20150810V	100	80	8	536	1.082
P20150812V	120	80	8	590	1.197

P2016

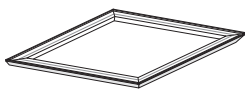

Telaio tavolo riunioni quadrato P. 120 con 4 gambe

Frame square meeting table D. 120 with 4 legs

Châssis table de réunion carré P. 120 avec 4 pieds

Estructura para mesa de juntas cuadrada P. 120 con 4 patas

	L	P	H	AL	CUO
				Alluminio	Cuoio
				Aluminium	Leather
				Aluminium	Cuir
				Aluminio	Cuero
P20161212V	120	120	8	625	1.128

P2016

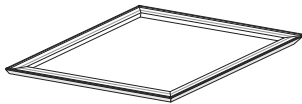

Telaio tavolo riunioni quadrato P. 150 con 4 gambe

Frame square meeting table D. 150 with 4 legs

Châssis table de réunion carré P. 150 avec 4 pieds

Estructura para mesa de juntas cuadrada P. 150 con 4 patas

	L	P	H	AL	CUO
				Alluminio	Cuoio
				Aluminium	Leather
				Aluminium	Cuir
				Aluminio	Cuero
P20161515V	150	150	8	790	1.477

P20173

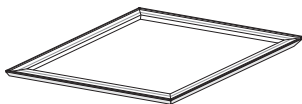

Telaio tavolo riunioni quadrato P. 150 con doppio basamento

Frame square meeting table D. 150 with double base

Châssis table de réunion carré P. 150 avec base double

Estructura para mesa de juntas cuadrada P. 150 con base doble

	L	P	H	AL	CUO
				Alluminio	Cuoio
				Aluminium	Leather
				Aluminium	Cuir
				Aluminio	Cuero
P201731515V	150	150	8	790	1.477

P2016

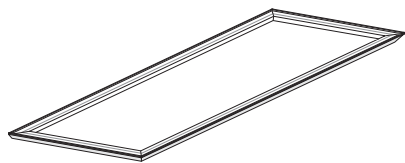

Telaio tavolo riunioni rettangolare P. 120 con 4 gambe

Frame rectangular meeting table D. 120 with 4 legs
Châssis table de réunion rectangulaire P. 120 avec 4 pieds
Estructura para mesa de juntas rectangular P. 120 con 4 patas

AL	CUO					
Alluminio	Cuoio					
Aluminium	Leather					
Aluminium	Cuir					
Aluminio	Cuero					

	L	P	H		
P20161230V	300	120	8	1.027	1.855

P20172

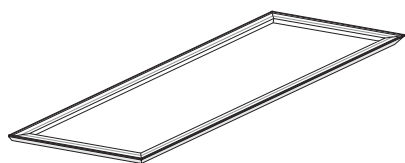

Telaio tavolo riunioni rettangolare P. 120 con 1 basamento e 2 gambe

Frame rectangular meeting table D. 120 with single base and 2 legs
Châssis table de réunion rectangulaire P. 120 avec base simple et 2 pieds
Estructura para mesa de juntas rectangular P. 120 con base unica y 2 patas

AL	CUO					
Alluminio	Cuoio					
Aluminium	Leather					
Aluminium	Cuir					
Aluminio	Cuero					

	L	P	H		
P201721230V	300	120	8	1.027	1.855

P20173

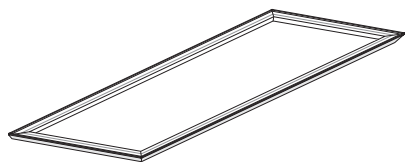

Telaio tavolo riunioni rettangolare P. 120 con doppio basamento

Frame rectangular meeting table D. 120 with double base
Châssis table de réunion rectangulaire P. 120 avec base double
Estructura para mesa de juntas rectangular P. 120 con base doble

AL	CUO					
Alluminio	Cuoio					
Aluminium	Leather					
Aluminium	Cuir					
Aluminio	Cuero					

	L	P	H		
P201731230V	300	120	8	1.027	1.855

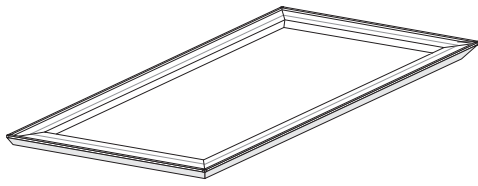

COTL Colore telaio
Frame colour
Couleur cadre
Acabado marco

TPPN Tipo piano
Desk type
Modele plateau
Tipo sobre

P2016

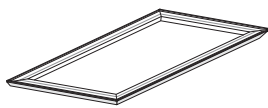

Telaio scrivania P. 100 con 4 gambe

Frame desk D. 100 with 4 legs
Châssis bureau P. 100 avec 4 pieds
Estructura para mesa P. 100 con 4 patas

AL	CUO					
Alluminio	Cuoio					
Aluminium	Leather					
Aluminium	Cuir					
Aluminio	Cuero					

	L	P	H		
P20161020J	200	100	8	708	1.340

P2016

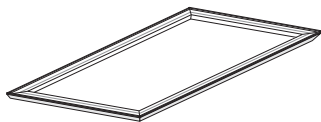

Telaio scrivania P. 120 con 4 gambe

Frame desk D. 120 with 4 legs
Châssis bureau P. 120 avec 4 pieds
Estructura para mesa P. 120 con 4 patas

AL	CUO					
Alluminio	Cuoio					
Aluminium	Leather					
Aluminium	Cuir					
Aluminio	Cuero					

	L	P	H		
P20161224J	240	120	8	777	1.495

P20172

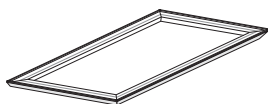

Telaio scrivania P. 100 con 1 basamento e 2 gambe

Frame desk D. 100 with single base and 2 legs
Châssis bureau P. 100 avec base simple et 2 pieds
Estructura para mesa P. 100 con base unica y 2 patas

AL	CUO					
Alluminio	Cuoio					
Aluminium	Leather					
Aluminium	Cuir					
Aluminio	Cuero					

	L	P	H		
P201721020J	200	100	8	708	1.340

P20172

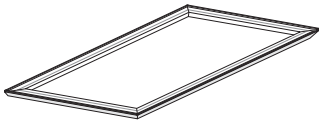

Telaio scrivania P. 120 con 1 basamento e 2 gambe

Frame desk D. 120 with single base and 2 legs
Châssis bureau P. 120 avec base simple et 2 pieds
Estructura para mesa P. 120 con base unica y 2 patas

AL	CUO					
Alluminio	Cuoio					
Aluminium	Leather					
Aluminium	Cuir					
Aluminio	Cuero					

	L	P	H		
P201721224J	240	120	8	777	1.495

P20173

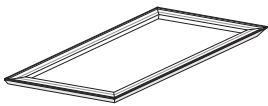

Telaio scrivania P. 100 con doppio basamento

Frame desk D. 100 with double base
Châssis bureau P. 100 avec base double
Estructura para mesa P. 100 con base doble

AL	CUO					
Alluminio	Cuoio					
Aluminium	Leather					
Aluminium	Cuir					
Aluminio	Cuero					

	L	P	H		
P201731020J	200	100	8	708	1.340

P20173

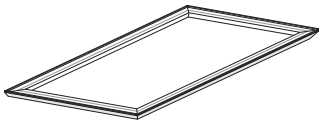

Telaio scrivania P. 120 con doppio basamento

Frame desk D. 120 with double base
Châssis bureau P. 120 avec base double
Estructura para mesa P. 120 con base doble

AL	CUO					
Alluminio	Cuoio					
Aluminium	Leather					
Aluminium	Cuir					
Aluminio	Cuero					

	L	P	H		
P201731224J	240	120	8	777	1.495

P2015

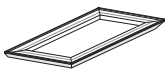

Telaio dattilo P. 60

Frame return D. 60
Châssis retour P. 60
Estructura ala P. 60

AL	CUO					
Alluminio	Cuoio					
Aluminium	Leather					
Aluminium	Cuir					
Aluminio	Cuero					

	L	P	H		
P20150606J	60	60	8	312	563
P20150610J	100	60	8	430	972
P20150612J	120	60	8	536	1.082

P2015

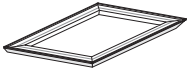

Telaio dattilo P. 80

Frame return D. 80
Châssis retour P. 80
Estructura ala P. 80

	L	P	H	AL	CUO
				Alluminio	Cuoio
				Aluminium	Leather
				Aluminium	Cuir
				Aluminio	Cuero
P20150810J	100	80	8	536	1.082
P20150812J	120	80	8	590	1.197

P2016

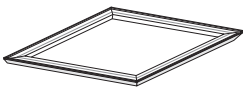

Telaio tavolo riunioni quadrato P. 120 con 4 gambe

Frame square meeting table D. 120 with 4 legs
Châssis table de réunion carré P. 120 avec 4 pieds
Estructura para mesa de juntas cuadrada P. 120 con 4 patas

	L	P	H	AL	CUO
				Alluminio	Cuoio
				Aluminium	Leather
				Aluminium	Cuir
				Aluminio	Cuero
P20161212J	120	120	8	625	1.128

P2016

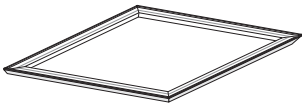

Telaio tavolo riunioni quadrato P. 150 con 4 gambe

Frame square meeting table D. 150 with 4 legs
Châssis table de réunion carré P. 150 avec 4 pieds
Estructura para mesa de juntas cuadrada P. 150 con 4 patas

	L	P	H	AL	CUO
				Alluminio	Cuoio
				Aluminium	Leather
				Aluminium	Cuir
				Aluminio	Cuero
P20161515J	150	150	8	790	1.477

P20173

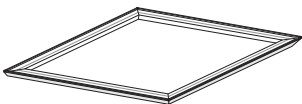

Telaio tavolo riunioni quadrato P. 150 con doppio basamento

Frame square meeting table D. 150 with double base
Châssis table de réunion carré P. 150 avec base double
Estructura para mesa de juntas cuadrada P. 150 con base doble

	L	P	H	AL	CUO
				Alluminio	Cuoio
				Aluminium	Leather
				Aluminium	Cuir
				Aluminio	Cuero
P201731515J	150	150	8	790	1.477

P2016

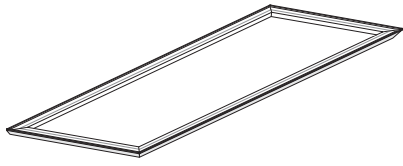

Telaio tavolo riunioni rettangolare P. 120 con 4 gambe

Frame rectangular meeting table D. 120 with 4 legs
Châssis table de réunion rectangulaire P. 120 avec 4 pieds
Estructura para mesa de juntas rectangular P. 120 con 4 patas

AL	CUO					
Alluminio	Cuoio					
Aluminium	Leather					
Aluminium	Cuir					
Aluminio	Cuero					

	L	P	H		
P20161230J	300	120	8	1.027	1.855

P20172

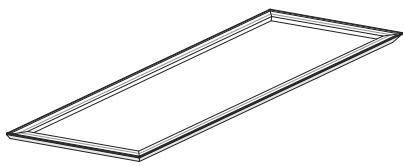

Telaio tavolo riunioni rettangolare P. 120 con 1 basamento e 2 gambe

Frame rectangular meeting table D. 120 with single base and 2 legs
Châssis table de réunion rectangulaire P. 120 avec base simple et 2 pieds
Estructura para mesa de juntas rectangular P. 120 con base unica y 2 patas

AL	CUO					
Alluminio	Cuoio					
Aluminium	Leather					
Aluminium	Cuir					
Aluminio	Cuero					

	L	P	H		
P201721230J	300	120	8	1.027	1.855

P20173

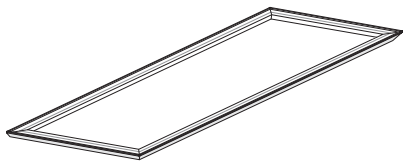

Telaio tavolo riunioni rettangolare P. 120 con doppio basamento

Frame rectangular meeting table D. 120 with double base
Châssis table de réunion rectangulaire P. 120 avec base double
Estructura para mesa de juntas rectangular P. 120 con base doble

AL	CUO					
Alluminio	Cuoio					
Aluminium	Leather					
Aluminium	Cuir					
Aluminio	Cuero					

	L	P	H		
P201731230J	300	120	8	1.027	1.855

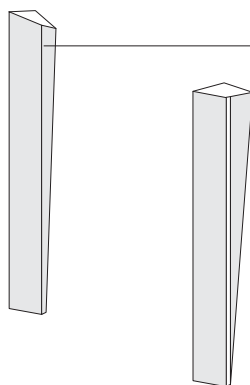

COGM Colore gamba
Leg finishing
Finition pied
Acabado pata

P20101520

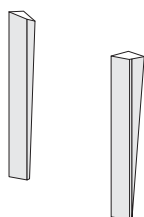

Coppia gambe

Pair of legs
Paire de pieds
Par de patas

AL	CUO					
Alluminio	Cuoio					
Aluminium	Leather					
Aluminium	Cuir					
Aluminio	Cuero					

	L	P	H		
P20101520	-	-	71,9	789	1.089

P20101555

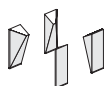

Gambe per tavolini da caffè (full set)

Legs for coffee tables (full set)
Pieds pour tables basses (full set)
Patas mesitas (full set)

AL	CUO					
Alluminio	Cuoio					
Aluminium	Leather					
Aluminium	Cuir					
Aluminio	Cuero					

	L	P	H		
P20101555	-	-	38,5	954	1.300

P201016

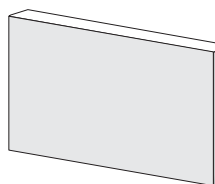

Gamba pannellata P. 100

Panel leg D. 100
Piètement en panneau P. 100
Pata panelada P. 100

AL	CUO					
Alluminio	Cuoio					
Aluminium	Leather					
Aluminium	Cuir					
Aluminio	Cuero					

	L	P	H		
P20101610	-	100	71,9	985	1.484

P201016

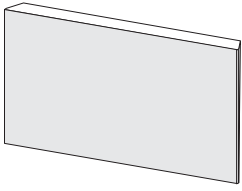

Gamba pannellata P. 120

Panel leg D. 120
Piètement en panneau P. 120
Pata panelada P. 120

AL	CUO					
Alluminio	Cuoio					
Aluminium	Leather					
Aluminium	Cuir					
Aluminio	Cuero					

	L	P	H		
P20101612	-	120	71,9	1.108	1.710

Bases | Base de support | Base central

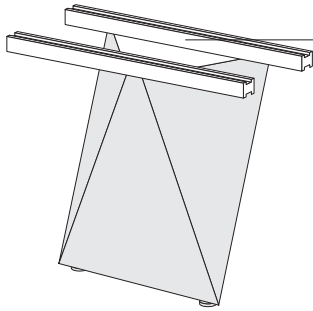

TIBS Tipo basamento
Basement type
Type de base
Modelo de base

P2019

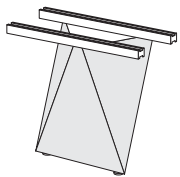

Basamento singolo P. 100 (barre di fissaggio incluse)

Single base D. 100 (bars included)
Base simple P. 100 (barres de fixation incluses)
Base unica P. 100 (barras de soporte incluidas)

AL

Alluminio

Aluminium
Aluminium
Aluminio

	L	P	H	
P2019100	-	100	71,9	1.394

P2019

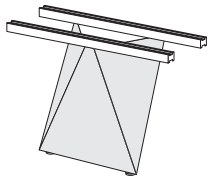

Basamento singolo P. 120 (barre di fissaggio incluse)

Single base D. 120 (bars included)
Base simple P. 120 (barres de fixation incluses)
Base unica P. 120 (barras de soporte incluidas)

AL

Alluminio

Aluminium
Aluminium
Aluminio

	L	P	H	
P2019120	-	120	71,9	1.419

P2019

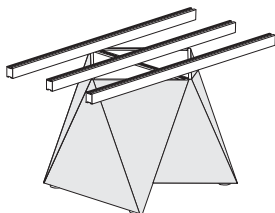

Basamento doppio P. 150 (barre di fissaggio incluse)

Double base D. 150 (bars included)
Base double P. 150 (barres de fixation incluses)
Base doble P. 150 (barras de soporte incluidas)

AL

Alluminio

Aluminium
Aluminium
Aluminio

	L	P	H	
P2019150	-	150	71,9	2.837

P2019

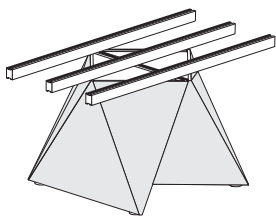

Basamento doppio P. 200 (barre di fissaggio incluse)

Double base D. 200 (bars included)
 Base double P. 200 (barres de fixation incluses)
 Base doble P. 200 (barras de soporte incluidas)

AL

Alluminio

Aluminium
 Aluminium
 Aluminio

	L	P	H	
P2019200	-	200	71,9	3.085

P201956200

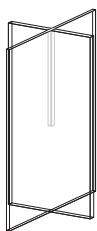

Basamento

Bases for desk
 Colonne
 Soporte

MTC

TR

TR
 TR
 TR

	L	P	H	
P201956200	48,5	48,5	64	419

Indice

Index | Index | Índice

66

Top access

Top access | Top access | Top access

68

Elettrificazione

Cable management | Electrification | Electrificación

70

Porta CPU

CPU holder | Support U.C. | Porta CPU

71

Accessori da tavolo

Table accessories | Accessoires de table | Accesorios para mesas

ERACLE

ERACLE
ERACLE

Accessori

Accessories | Accessoires | Accesorios

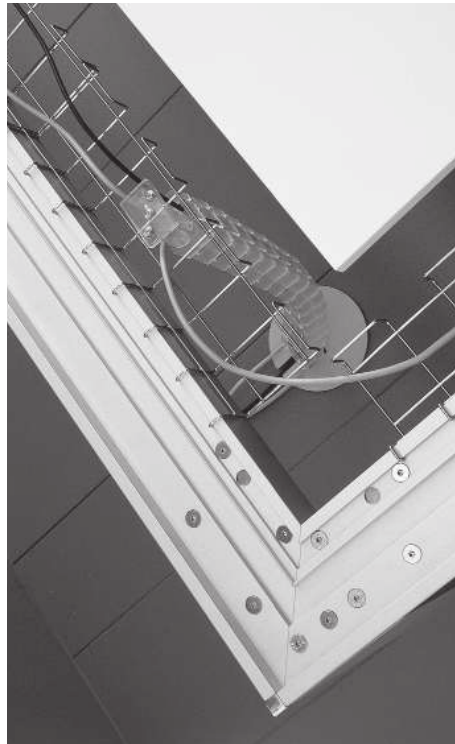

ERACLE

Top access | Top access | Top access

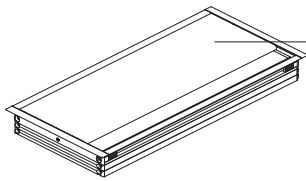

COFL Colore Magic-Top
 Magic-Top colour
 Couleur Magic-Top
 Acabado de Magic-Top

VTR

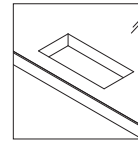

Foro su piano in vetro
 Hole on glass top
 Perçage sur plateau verre
 Hueco en sobre de vidrio

MAGGVTR

+ 195 / PCS

GRES

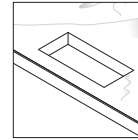

Foro su piano in gres
 Hole on porcelain tile top
 Perçage sur plateau en grès cérame
 Hueco en sobre de gres porcelánico

MAGGRES

+ 70 / PCS

P0105MT

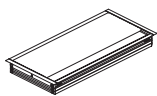

Magic-Top H. 2,4 apertura 1 lato

Magic-Top H. 2,4 1-side opening
 Magic-Top H. 2,4 ouvrable sur 1 coté
 Magic-Top H. 2,4 se abre por un lado

	L	P	H	EPX	AL	BR
				Metallo	Alluminio	Brill
				Metal	Aluminium	Brill
				Metal	Aluminium	Brill
				Metal	Aluminio	Brill
P0105MTB1	12,4	12,4	2,4	50	48	60
P0105MTB2	26,4	12,4	2,4	63	57	73
P0105MTB3	45,4	12,4	2,4	73	71	92

P0105220
P0105450

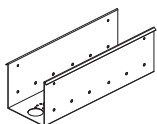

Cestello per Flip-Top L. 26, L. 45

Metal tray for Flip-Top L. 26, L. 45
 Bac pour Flip-Top L. 26, L. 45
 Cesta para Flip-Top L. 26, L. 45

	L	P	H	Metallo
				Metal
				Metal
				Metal
				Metal
P0105220	24,5	10	7	25
P0105450	43,5	10	7	42

Top access | Top access | Top access

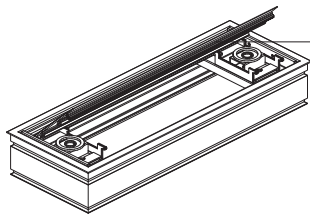

COFL Colore Magic-Top
 Magic-Top colour
 Couleur Magic-Top
 Acabado de Magic-Top

VTR

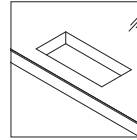

Foro su piano in vetro
 Hole on glass top
 Perçage sur plateau verre
 Huevo en sobre de vidrio

MAGGVTR + 195 / PCS

GRES

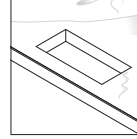

Foro su piano in gres
 Hole on porcelain tile top
 Perçage sur plateau en grès cérame
 Huevo en sobre de gres porcelánico

MAGGGRES + 70 / PCS

P010514

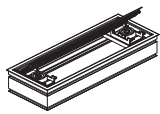

Flip-Top, apertura 2 lati

Flip-Top, 2-side opening
 Flip-Top, ouvrable sur 2 cotés
 Flip-Top, se abre por dos lados

EPX	AL	BR				
Metallo	Alluminio	Brill				
Metal	Aluminium	Brill				
Metal	Aluminium	Brill				
Metal	Aluminio	Brill				

	L	P	H			
P010514124	12,4	12,4	5	93	76	101
P010514264	26,4	12,4	5	126	104	131
P010514454	45,4	12,4	5	169	147	180

P0105220
P0105450

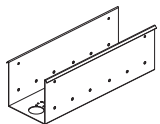

Cestello per Flip-Top L. 26, L. 45

Metal tray for Flip-Top L. 26, L. 45
 Bac pour Flip-Top L. 26, L. 45
 Cesta para Flip-Top L. 26, L. 45

Metallo						
Metal						
Metal						
Metal						

	L	P	H			
P0105220	24,5	10	7	25		
P0105450	43,5	10	7	42		

P010510A

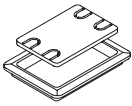

Passacavi rettangolare

Rectangular grommet
Passecables rectangulaire
Pasacables rectangular

PLA						
PG						
PG						
PG						
PG						

	L	P	H	
P010510A	7,5	5,4	-	7
P010515A	7,5	5,4	-	21

*Comprensivo di foro su piano in melaminico, legno o cuoio
*Inclusive of desk top hole on melamine, wood or leather top
*Trou compris sur plateau en mélaminé, bois ou cuir
*Hueco incluido en sobre de melamina, madera o cuero

P010510



Passacavi rotondo

Round grommet
Passecables rond
Pasacables redondo

PLA	CRM					
PB-PG-PN	Inox lucido					
PB-PG-PN	Stainless Steel					
PB-PG-PN	Inox brossé poli					
PB-PG-PN	Acero inoxidable					

	Ø	P	H	
P010510CN	6	-	-	7
P010510DN	8	-	-	7
P010510CS	6	-	-	21
P010510DS	8	-	-	21

*Comprensivo di foro su piano in melaminico, legno o cuoio
*Inclusive of desk top hole on melamine, wood or leather top
*Trou compris sur plateau en mélaminé, bois ou cuir
*Hueco incluido en sobre de melamina, madera o cuero

P010520



Passacavi rotondo

Round grommet
Passecables rond
Pasacables redondo

PLA	CRM					
PB-PG-PN	Inox lucido					
PB-PG-PN	Stainless Steel					
PB-PG-PN	Inox brossé poli					
PB-PG-PN	Acero inoxidable					

	Ø	P	H	
P010520CN	6	-	-	21
P010520DN	8	-	-	31
P010520CS	6	-	-	34
P010520DS	8	-	-	44

*Comprensivo di foro su piano in melaminico, legno o cuoio
*Inclusive of desk top hole on melamine, wood or leather top
*Trou compris sur plateau en mélaminé, bois ou cuir
*Hueco incluido en sobre de melamina, madera o cuero

P010500

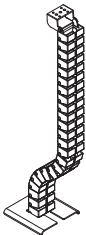

Canalizzazione verticale

Vertical cable duct
Montée vertical des cables
Canalización salida cables

PLA						

	L	P	H	
P010500	75	-	-	50

P010502



Guaina raccogli-cavi

Cable duct
Gaine pour remontée des câbles
Cubierta flexible para cables



Nero

Black
Noir
Negro

Guaina raccogli-cavi non comprensiva di base e fissaggio a scrivania

Cable duct not inclusive of plate and desk-connecting kit

La gaine ne comprend pas la base ni la fixation au bureau

Cubierta flexible para cables no inclusiva de base y fijación a la mesa

	L	P	H	
P010502PN	150	2,5	2,5	15

P010504



Guaina raccogli-cavi con base e fissaggio al piano

Cable tidy sleeving with plate and desk-connecting kit
Gaine pour remontée des câbles avec la base et la fixation au bureau
Cubierta flexible para cables con base y fijación a la mesa



Nero

Black
Noir
Negro

	L	P	H	
P010504PN	150	2,5	2,5	52

P010503

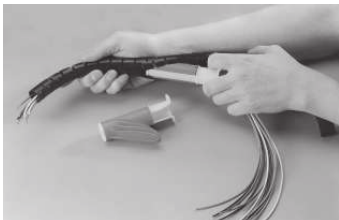

Accessorio per l'inserimento cavi

Accessory for cable insertion
Accessoire pour l'insertion de câbles
Accesorio para inserción de cables



	L	P	H	
P010503	-	-	-	14

PZE000090000 PZE000095000

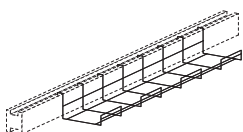

Cestello portacavi

Basket for cable management
Panier passacables en fil d'acier
Viga portacables en rejilla de acero



Metallo

Metal
Metal
Metal

	L	P	H	
PZE000090000	39	10	6	20
PZE000095000	39	10	10	30

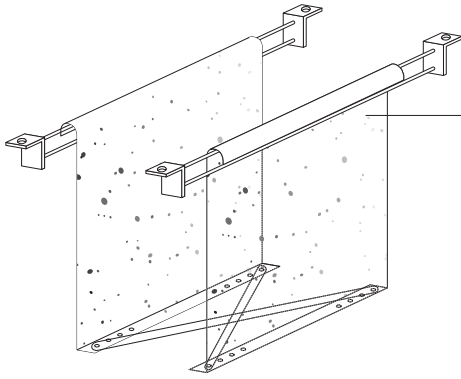

COPR Colore porta CPU
 CPU holder colour
 Couleur support U.C.
 Acabado de porta CPU

P2004100

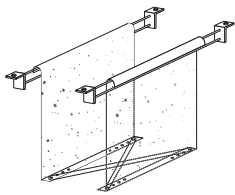

Porta CPU sospeso
 Hanging CPU holder
 Support U.C. suspendu
 Porta CPU suspendido

EPX						
EB - EG						
EB - EG						
EB - EG						

	L	P	H	
P2004100	-	100	-	108
P2004120	-	120	-	117

P010142TOLO

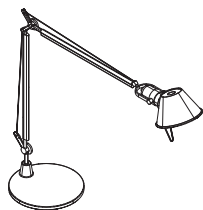

Lampada Tolomeo 220V, completa di supporto

Tolomeo lamp 220V, including bracket
Lampe Tolomeo 220V, support compris
Lámpara Tolomeo 220V, soporte incluido



	L	P	H	
P010142TOLO	-	-	-	426

P010142COST

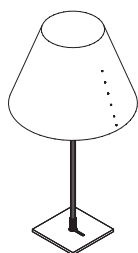

Lampada Costanzina 220V, completa di supporto

Costanzina lamp 220V, including bracket
Lampe Costanzina 220V, support compris
Lámpara Costanzina 220V, soporte incluido



	L	P	H	
P010142COST	-	-	-	320

P010145WH

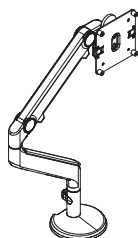

Braccio porta monitor

LCD monitor arm
Bras-support d'écran
Brazo portamonitor



Bianco

White
Blanc
Blanco

	L	P	H	
P010145WH	-	-	-	308

P0195015

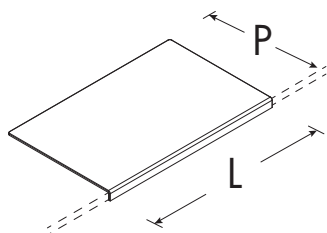

Sottomano in cuoio

Leather pad
Sous-mains en cuir
Vade de escritura en cuero



Cuoio

Leather
Cuir
Cuero

	L	P	H	
P019501506050	61	49,5	1,8	256
P019501507550	76	49,5	1,8	318
P019501510050	101	49,5	1,8	432

